

# Installation Guide

This procedure is designed as an installation aid. Skilled tradespeople that are familiar with general construction and electrical installation techniques should perform the installation. Licensed electricians should provide electrical installation connections. Installations and connections should be done in accordance with all national and local codes and permits. In no way is this document intended to construe warranty or fitness of use of the products described, nor is it intended to provide safety instruction for those installing the product.

## ⚡ WARNING

Before proceeding with installation or service maintenance of this product:

- Disconnect power to reduce electrical shock risk.
- Review the entire Installation Guide.
- Inspect this properly packaged product for any damage that may have occurred during transit.
- Verify product application complies with manufacturer design recommendations.
- Verify the availability of necessary tools and incidental material.
- Verify applicable code requirements. Field assembly and installation are subject to acceptance by local inspection authority.
- Appropriate safety equipment to be determined by end user, per applicable safety standards and precautions.

## Bracket F installation method

### -Installation Tools Reference - Packing List:

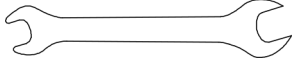

13mm inner  
Open wrench





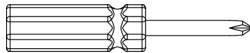



6mm inner  
hexagon wrench

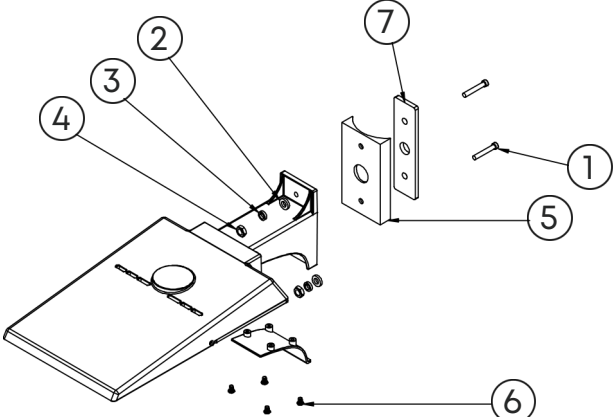

cross  
screwdriver

Note: Installation tool is not included with product.

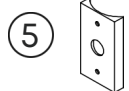
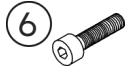

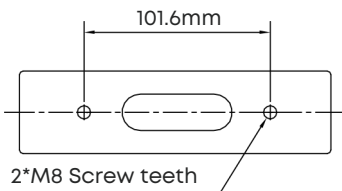
 1 M8*50mm 2PCS	 2 M8mm 2PCS	 3 M8mm 2PCS
 4 M8mm 2PCS	 5 Through 1PCS	 6 M4*8mm 4PCS
 7 E Stamping sheets 1PCS	 <p>101.6mm 2*M8 Screw teeth</p>	

A

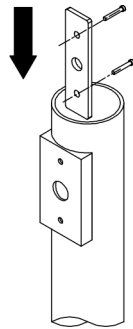
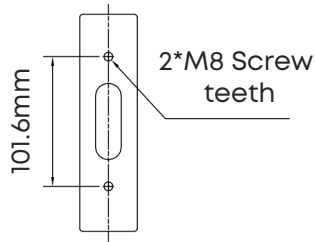

Step 1-Install the backplane and bracket adapter on the pole with top bolts, nuts and washers

B

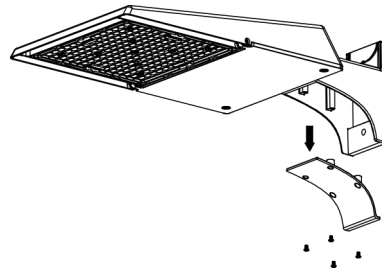

Step 2 - Remove the screw and open the cover

C

Torque force  $\geq 8.5\text{N}\cdot\text{m}$  until locking

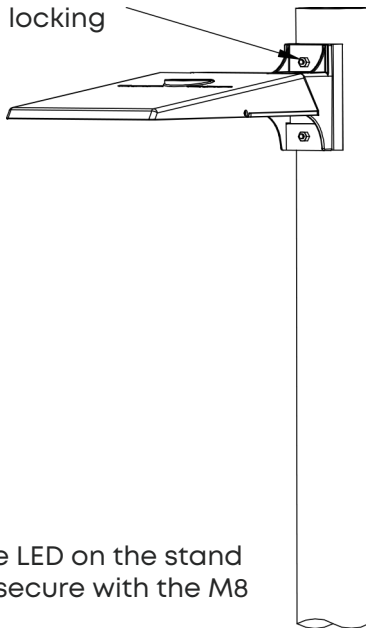

Step 3 - Fix the LED on the stand adapter and secure with the M8 screw

D

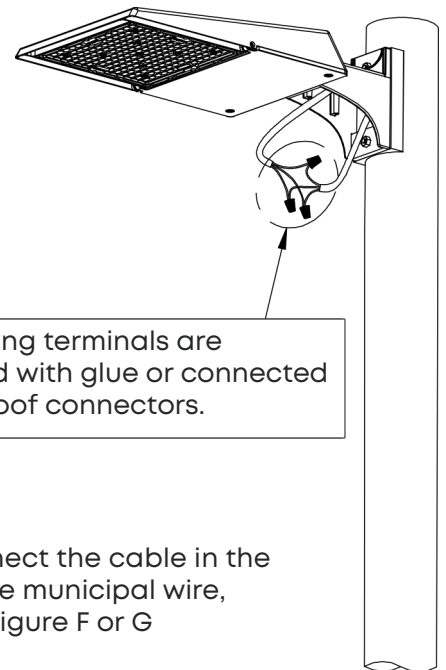

Note: The wiring terminals are waterproofed with glue or connected with waterproof connectors.

Step 4 - Connect the cable in the F holder to the municipal wire, as shown in Figure F or G

E

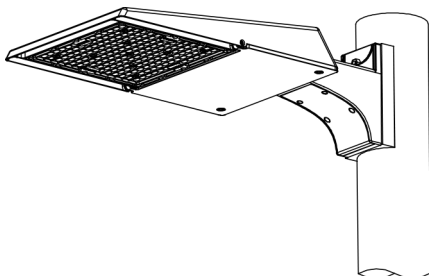

Step 5 - Finally, install the bracket cover and secure it with the screw

F

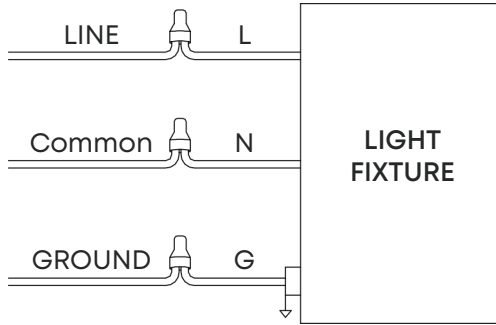

G

**0-10V Dim Wiring**

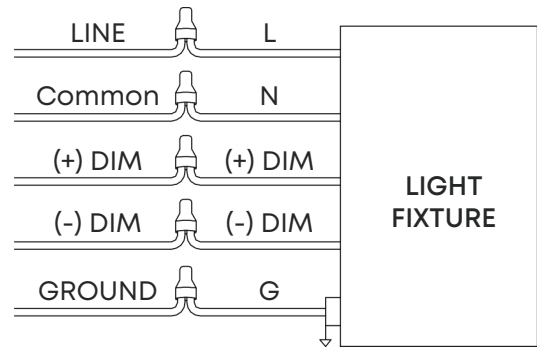

H

1. Adjust the color temperature and power according to the following instructions and loosen the waterproof plug fixture, as shown in Figure 8.  
Power factory Settings: On/off option.  
Color temperature Factory setting: 4000K (CCT).
2. Select the power level by flipping the dip switch, as shown in Figure 9.  
Factory power 150W; Power dip switch first gear :115W, second gear :75W, third gear and fourth gear: empty (Customization).  
Factory power 230W; Power dip switch first gear :200W, second gear :180W, third gear and fourth gear: empty (Customization).
3. Select the color temperature (CCT) by flicking the dip switch, as shown in Figure 10.  
Color temperature DIP switch: First gear :3000K; second gear :4000K and third gear :5000K.
4. Reinstall the waterproof plug and tighten it.

