

200+ Patent Certificates
\$1,000,000+ Annual Energy Saving
20,000+ Projects Successfully Installed



SE All in One Solar Street Light

Power: 10W - 60W



Innovative & Tailored
Lighting Solutions for **Success**
www.aokledlight.com

Discover **SE** Series



For other certificates please request



>2000 times

Lifespan Cycle
High quality Li-ion battery
Intelligent temperature control

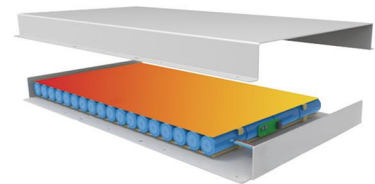

Integral
Monocrystalline
Silicon Solar Panel



25 Years
Lifespan



Conversion Rate
up to 30%

- The SE solar LED street light features an all-in-one design with a low profile, including a PIR/microwave motion sensor and a smart controller integrated into the design.
- The bilateral solar panel design makes it suitable for use in remote regions and areas without electricity supply.
- Using LiFePO4 batteries, which can charge and discharge for over 2000 cycles, offer a safer and relatively minor size and longer lifespan.
- Operating time: With the intelligent model enabled, it can operate for 5 to 7 days during rainy weather.
- The controller features an intelligent energy-saving mode with selectable levels, extending the lighting duration and automatically adjusting brightness.



WARRANTY

3 Year Limited Warranty,
5 Year Preferred Warranty.
Please consult with our sales for detailed agreement.

Advantages of SE All in One Solar Street Light

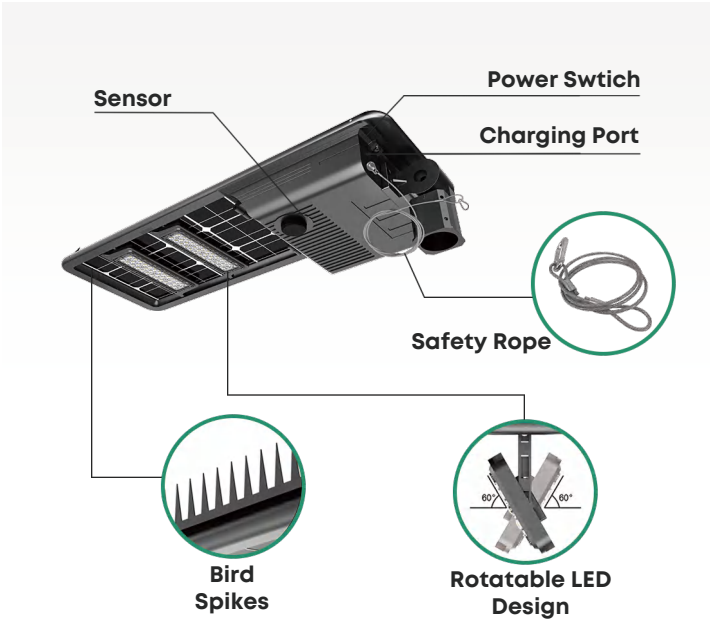

Grid Hybrid Power Solution Optional

Standard Configuration Version

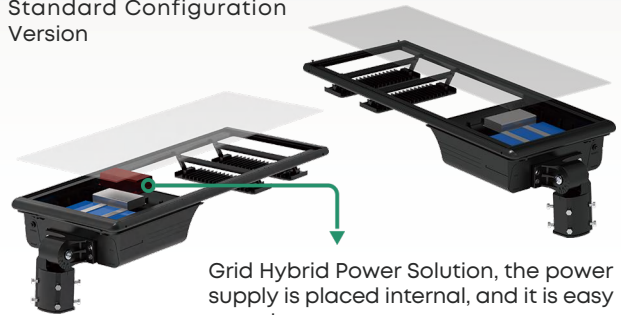

Grid Hybrid Power Solution, the power supply is placed internal, and it is easy to replace.

When the battery voltage is lower than the set value, the power supply will switch to mains power, and when the voltage is higher than the set value, it will switch to battery power. The standard configuration does not include hybrid mains power function.

 Ultra-high light efficiency. 10 watts equivalent to at least 20 watts of others.

 Bifacial solar panels with an increased overall conversion efficiency of 30%.

 Equipped with unique anti-theft technology on the battery door for added security. Designed for easy battery replacement.

 Rotatable LED module for ease of installation and optimal solar panel angle adjustment to follow the sun's path.

 Multiple installation methods available to suit various applications, such as light poles, wall surfaces, and more.

 Designed to replace traditional 35-400 watt lighting systems. With options from 10W to 60W, it can meet all road lighting requirements.

30⁺ Over 30 different road optical designs available to accommodate various road conditions while ensuring efficient use of light.

 Featuring a built-in PIR/microwave motion sensor and smart controller, as well as complementary AC and DC capabilities (Optional).

Energy-efficient Lighting Systems

Single lumen efficiency **>200lm/W** achieve higher illumination



High Efficiency



Long Lifespan



Less Calorific Value



Low Light Decay

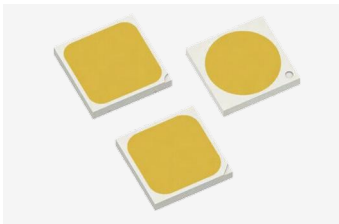

The bracket is strengthened

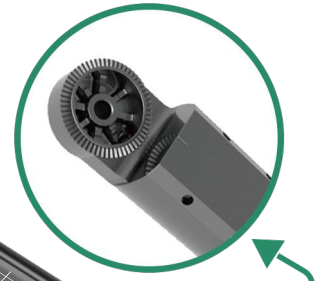

Seoul 5050 LED chip creates a first-class light source. By choosing it, single lumen efficacy $>200\text{lm/W}$, with the aluminum lamp base and sealed lens, with its excellent heat dissipation, it is as if the LED chip has been placed in a sealed unit. Thus it maintains high brightness levels with very little fading. The sealed lenses are made of strong UV-protected PC and are aging and shock-resistant; The well-optimized light distribution makes for a more uniform and wider lighting area.

Multiple Distribution Options

General solution, accurate light distribution design, flexible to match the project requirements:

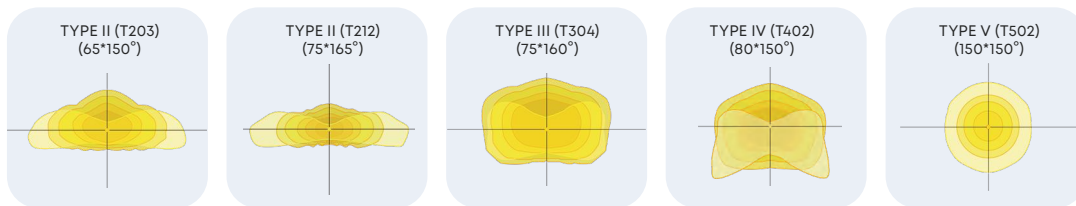
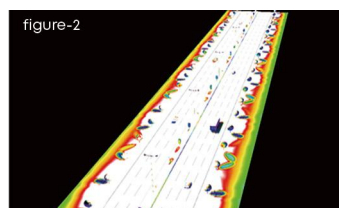
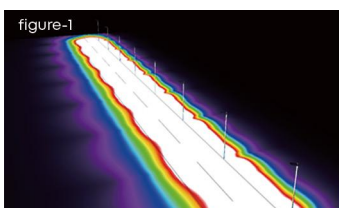

Figure-1: Example of rural branch road

Figure-2: Example of mian road or avenue



Planning and analysis of street lights can be done by using lighting simulation & design software, which allows the lighting effect a more intuitive display. It uses rendering, the process of generating an image from a model, by means of computer programs resulting in different tools for measuring the simulated light levels.

Advantages of controller

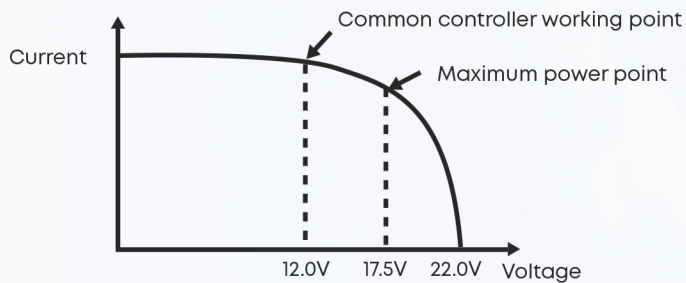

(take 12V battery system as an example)

- 1) Moving Track MPPT maximum power tracking technology is adopted to improve the tracking efficiency and speed by more than 20%;
- 2) UltraGreen power control technology with extremely low static power consumption and sleep current;
- 3) 10 time-periods programmable load power/time control;
- 4) Multiple intelligent power modes can be selected, and the load power can be automatically adjusted according to the battery power;
- 5) Multiple protection functions such as battery /PV reverse connection protection, LED short circuit/open circuit/power limit protection;
- 6) Aluminum metal housing, IP67 waterproof rating, can be used in a variety of harsh environments
- 7) Extensible IoT remote communication monitoring function;

Detection distance

Remote control distance 5-8 meters, installation height and environment and other factors will affect the controller sensitivity, please refer to the actual field.

Note: Please do not place 2 or more lights within 12 meters at the same time while using the remote controller, receiving or sending may fail.

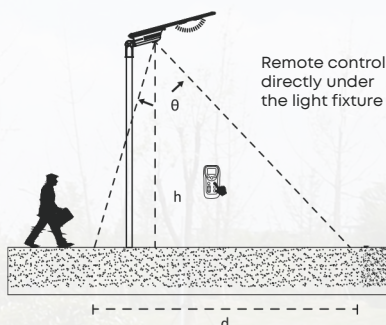

Inductive Type (alternative)	θ -Angle (X-axis rotation: 360°)	h (Height of lamp rod)	d (Inductive width)
IR (Infrared)	60°	6-8m	6-10m
WB (Microwave)	65°	6-10m	7-10m

*Remote control is optional



Bifacial Solar Panel

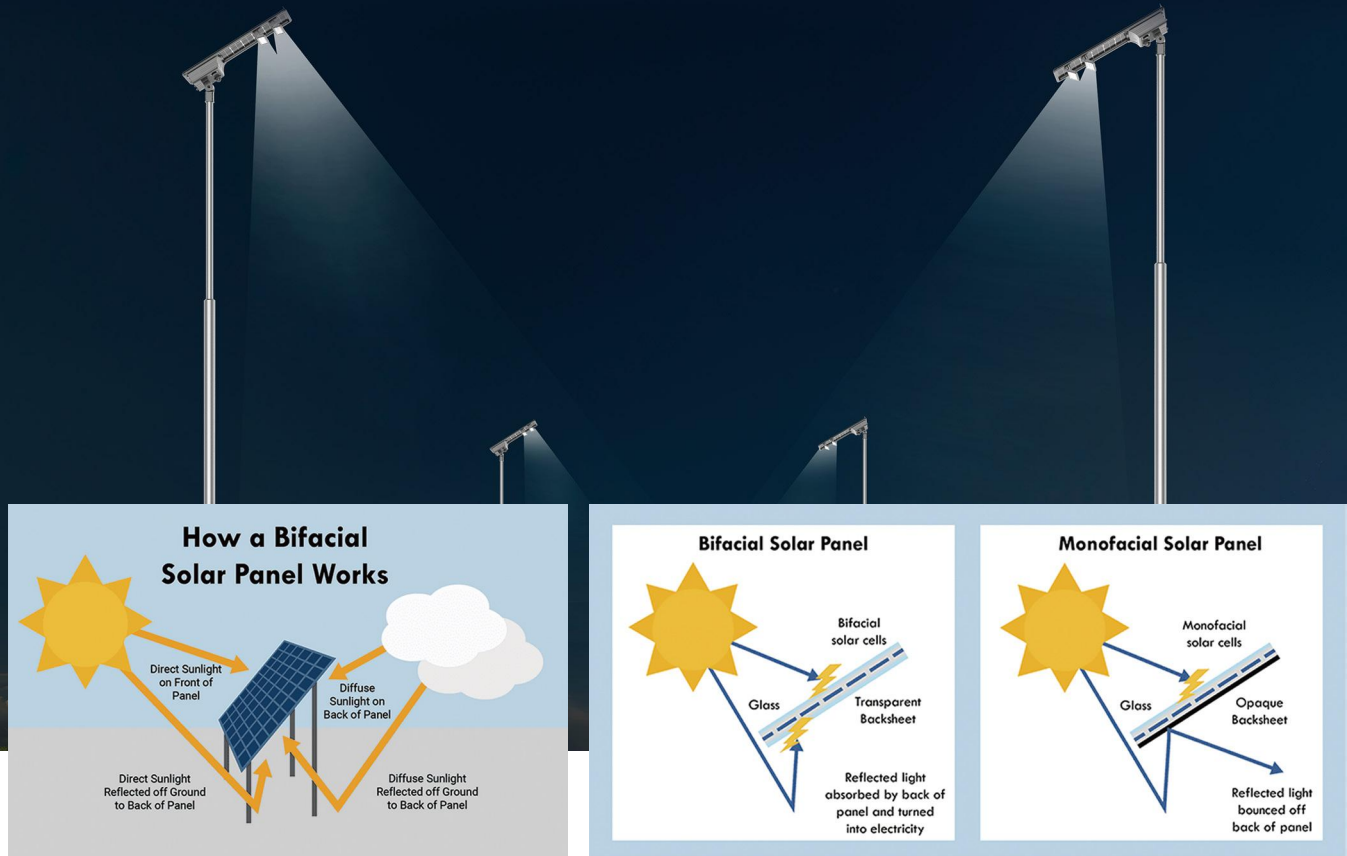

Cost-effectiveness

Cost is one of the biggest factors a big factor – particularly in the case of monofacial modules. The cost of bifacial modules has fallen precipitously over the last two decades. Notably, as costs have decreased, so too has the cost gap between mono- and bifacial modules.

High Conversion Efficiency

There is no doubt bifacial modules will increase power production. Results and studies have shown that bifacial modules can produce additional power between 10-20% over monofacial panels. If conditions are optimized and single-axis trackers adopted, the additional power can be as high as 30-40%.

Other Benefits

• Site Selection:

The site selection of the bifacial panels can be optimized. For places where land is less electricity supply and expensive, monofacial panels should be laid in the right direction to ensure maximum energy collection. However, bifacial modules can have optimal spacing and therefore higher yields. Also, bifacial yields are greater where the diffuse light energy is greater, which means at higher latitudes the bifacial yield will be greater than at lower latitudes.

• High Albedo:

The environment has a high albedo that is great for bifacial panels compared with monofacial panels. Desert sand is even a better option. The best option is white concrete or highly reflective roof foil. Snow and ice also have a very high albedo.

• Tilt:

More flexible than monofacial panel. Bifacial panels can receive light even at sunset. This will vary from site to site, but generally, 2~15 degrees more than the monofacial tilt has been shown to be effective.

Application Reference

- Road & street lighting
- Residential area lighting
- Garden, parks & perimeter lighting
- Parking lot lighting
- Industrial and commercial park lighting
- Railway & station side lighting
- Riverside & jogging track lighting



Smart City Starts with **Smart Lighting**

AUTONOMY CONTROL REFERENCE

30%~100% MOTION SENSOR MODE

Constant 30% brightness (turns on at dusk, turns off at dawn);

100% brightness turns on for 2 minutes when motion is

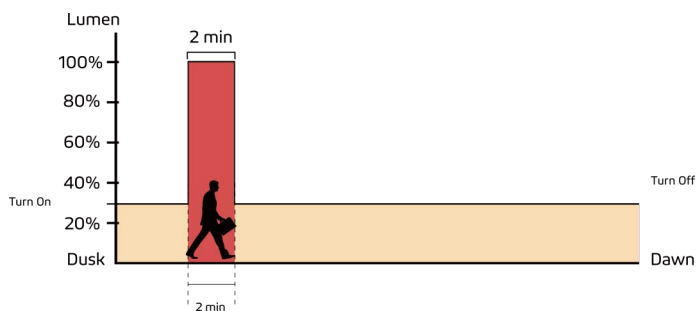

20%~80% MOTION SENSOR MODE

Constant 20% brightness (turns on at dusk, turns off at dawn);

80% brightness turns on for 2 minutes when motion is

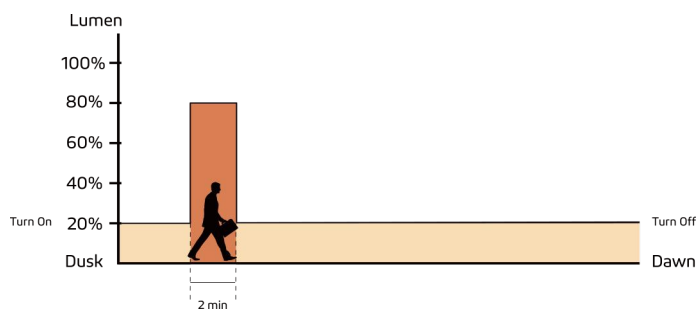

100% CONSTANT MODE

100% brightness from dusk to dawn.

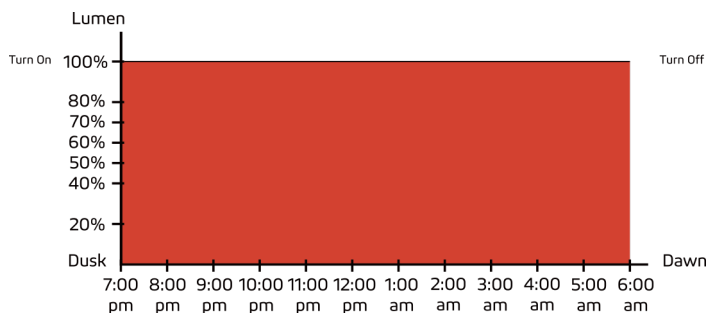

70% CONSTANT MODE

70% brightness from dusk to dawn.

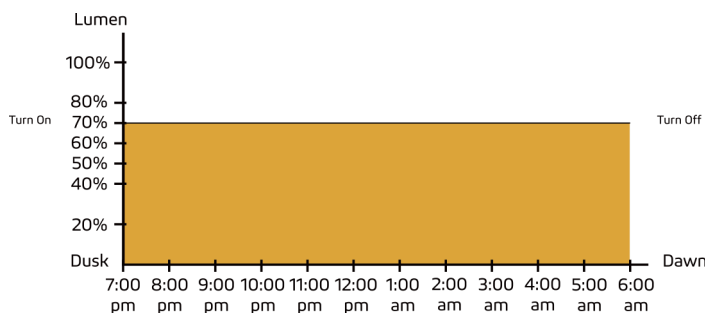

40% CONSTANT MODE

40% brightness from dusk to dawn.

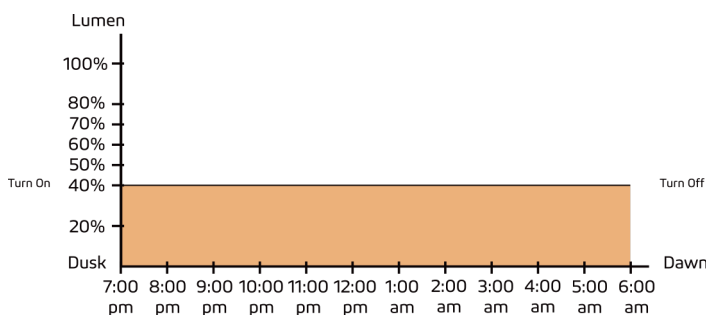

PROGRAMMABLE CONTROLLER OPTIONAL



A programmable remote control is used to adjust the appropriate plan according to the different periods of daylight and road conditions in each area and season.

Default mode

- 1) 4H-Detected 100%, None 30%;
- 2) 3H-Detected 70%, None 30%;
- 3) 3H-Detected 50%, None 20%;
- 4) 4H-Detected 30%, None 10%;
- 5) Subject to specific order

SMART LIGHTING CONTROL SYSTEM

The interface includes a sidebar menu with options: Sysinfo, ProjectManagement, GISMap, Alarm, ReportManagement, UserManagement, and SystemConfig. The main area shows a map with street lights and a 'Light List' table.

Number	Status	Brightness	Alarm
1	📶	0%	No
2	📶	0%	No
3	📶	0%	No
4	📶	0%	No
5	📶	0%	No
6	📶	0%	No
7	📶	0%	No
8	📶	0%	No
9	📶	0%	No

PN	Signal status	Update time	street lamp brightness	Battery voltage(V)	Battery power(W)	Solar panel power(W)	Street Lamp Power(W)	F info	Operation
GA520200357797	📶	2020-08-05 00:05:57	70	23.8	0	0	17		Edit History Parameter
GA520201497859	📶	2020-08-05 00:06:00	70	23.8	0	0	17		Edit History Parameter
GA520200753578	📶	2020-08-05 00:06:27	70	23.8	0	0	17		Edit History Parameter
GA520200777420	📶	2020-08-05 00:04:23	70	23.8	0	0	17		Edit History Parameter
GA520200192064	📶	2020-08-05 00:08:35	70	23.9	0	0	17		Edit History Parameter
GA520200346577	📶	2020-08-05 00:04:23	70	23.7	0	0	17		Edit History Parameter
GA520200619501	📶	2020-08-05 00:05:34	70	23.7	0	0	17		Edit History Parameter
GA520200415308	📶	2020-08-05 00:05:34	70	23.8	0	0	17		Edit History Parameter

DATA & PROJECT MANAGEMENT

The interface shows project settings and a detailed lamp status table.

Lamp status	Lamp number	Lamp status	Network status	Update time	Brightness(%)	Wireless module address	Lamp power(W)	Charging stage
📶	000001	📶	📶	2019-05-14 05:53:55	60%	0002020	8.43	There is no charge
📶	000002	📶	📶	2019-05-14 05:53:58	60%	0002070	5.83	There is no charge
📶	000003	📶	📶	2019-05-14 05:54:26	60%	0002023	9.34	There is no charge
📶	000004	📶	📶	2019-11-28 05:23:57	0%	0002298	0	There is no charge

Bar chart: covered-Power Generation/Power Consumption Report. Legend: 000001Energy used, 000002Power generation.

The Internet of Things solar street light management system can pre-set one or more lighting modes according to the different time of day and traffic flow, automatically turn on or off any light, and adjust the switching time and illumination according to environmental requirements to achieve the purpose of energy-saving and consumption reduction.

The integrated system is mainly composed of a street light component a centralized controller, a single light controller, and a smart cloud platform. The centralized controller and the single light controller aggregate the data collected by the single light via the GPRS/NB-IoT wireless communication network. The centralized controller uploads data to the system cloud platform through GPRS data flow, providing data dependence for mobile phone and computer terminal access.

APP CONTROL



Remote monitoring real time monitoring

With wireless communication function, through the intelligent management system of solar street light and wireless module, have remote monitoring and real-time monitoring.



Automatic fault alarm

Real-time monitoring of solar panel voltage, current, power, battery charging and discharging current, voltage, load working state, controller working state data, and fault automatic alarm.



Remote control

Support remote switch on/off dimmer and battery, load parameter modification.



Fault tracking and precise positioning

Multi peak PWM technology, suitable for partial shading or damage of photovoltaic cells, and the tracking efficiency is more than 99%.



Map location

Using GPS maps, with geographic display capabilities.



*Note :APP is only available in 4G scheme

Smart Control Ready For Efficient Management

Application of **Typical Networking** of Smart Street Light (optional)



Single lamp control

Control street light switch, brightness adjustment, current acquisition. Voltage acquisition, power calculation and power factor functions.



Wireless network

From the device to the cloud, NB-IoT, GPRS, LTE and other cellular networks are used, without cabling.



Fault management

The street light can automatically report fault information, troubleshoot faults through the platform, and query historical faults.



Energy management

Supports online monitoring and storage of energy consumption and configuring energy saving policies.



Intelligent monitoring

Support remote monitoring and remote control through PC web and mobile APP.



Big data analysis

Based on the massive data of the platform, street light fault analysis and energy consumption analysis can be carried out to provide a basis for the maintenance of street light equipment to save energy and reduce consumption.

Application of Typical IOT networking

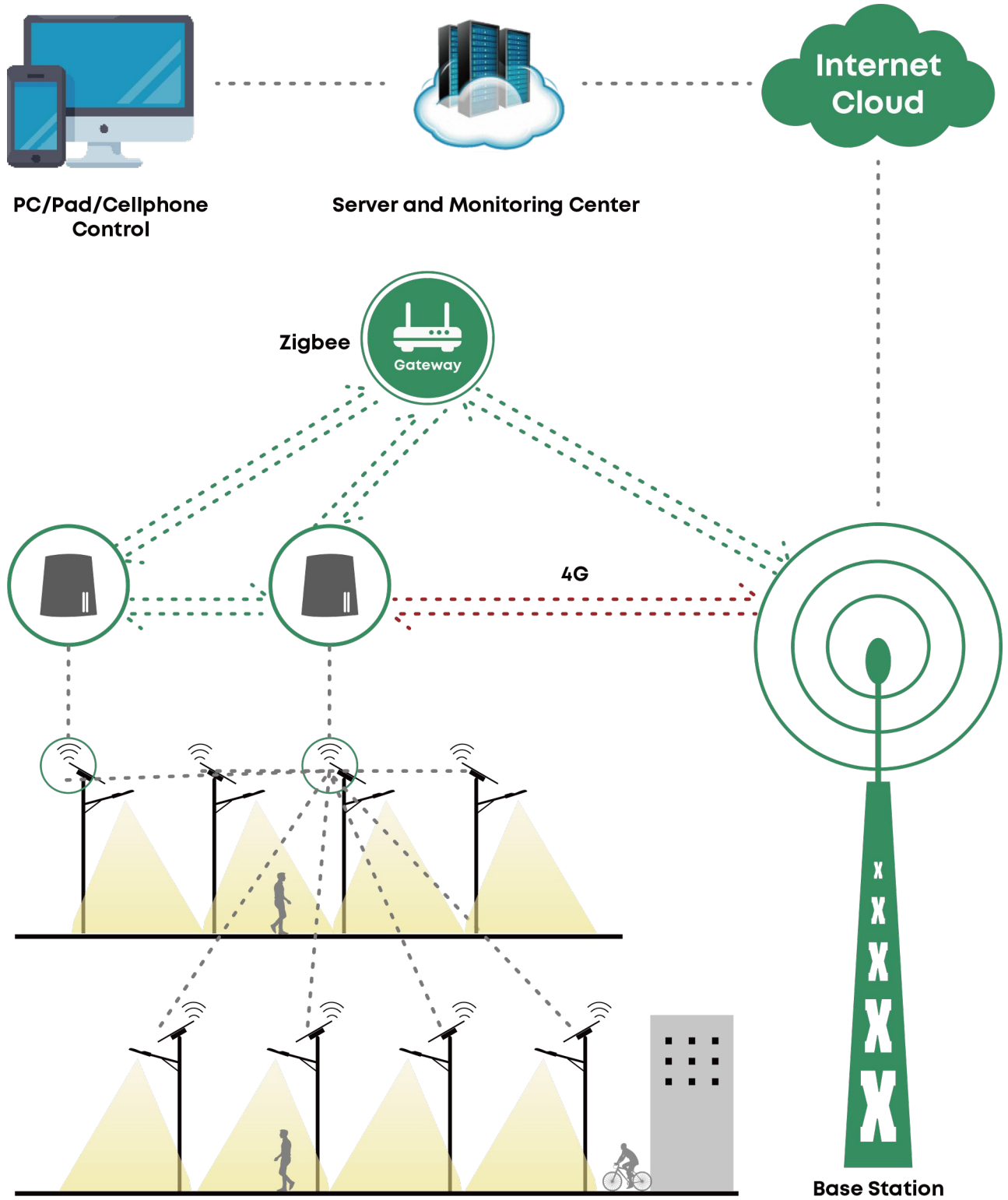

Parameter Table

Electrical Data						
Model	AOK-10WsE	AOK-20WsE	AOK-30WsE	AOK-40WsE	AOK-50WsE	AOK-60WsE
Power(W)	10W/15W	20W/25W	30W/35W	40W/45W	50W	60W
Control Option	Photocell sensor, timing, dimming, intelligent power saving, microwave sensor. 4G, Zigbee, Smart Lighting Control optional.					
Photometric Data						
LED Manufacturer	Seoul					
LED Model	Seoul 5050					
Lens	Polycarbonate					
Efficacy (lm/W, Std. Dev. ±5%)@CCT=5700K, CRI>70Ra	200lm/W	190lm/W	196lm/W	192lm/W	192lm/W	190lm/W
Luminous Flux (lm, Std. Dev. ±5%)@CCT=5700K, CRI>70Ra	2000lm	3800lm	5880lm	7680lm	9600lm	11400lm
ULOR	= 0%, @ Luminaire inclination 0°					
CCT	3000K, 4000K, 5000K, 5700K, 6500K					
CRI	70Ra, 80Ra, 90Ra optional					
Beam Angle	T203(65°*150°) / T212(75°*165°) / T304(75°*160°) / T402(80°*150°) / T502(150°*150°)					
Mechanical Data						
IP Rating	IP65, according to standard EN 60529					
SCx	Front: 0.3465 m²; Front-side: 0.0535 m²; Side: 0.0622 m²;	Front: 0.3465 m²; Front-side: 0.0535 m²; Side: 0.0622 m²;	Front: 0.4143 m²; Front-side: 0.0535 m²; Side: 0.0669 m²;	Front: 0.4831 m²; Front-side: 0.0535 m²; Side: 0.0706 m²;	Front: 0.5537 m²; Front-side: 0.0535 m²; Side: 0.0743 m²;	Front: 0.6215 m²; Front-side: 0.0535 m²; Side: 0.0790 m²;
Housing	Heavy-duty die-cast aluminum (EN AC-46100)					
Surface Treatment	Anti-UV thermosetting polyester / 80 micron epoxy primer + Anti-UV thermosetting polyester (for extremely corrosive environments).					
Painting	Black, custom color on request, C5-grade painting.					
Mounting	Universal/Wall mount/Round pole/Square pole					
Configuration Data						
Photovoltaic Panel	Bifacial monocrystalline solar panel					
Solar Panel	18V/30W	18V/40W	18V/50W	18V/60W	18V/70W	18V/80W
Li-ion Battery	153.6WH	230.4WH	307.2WH	384.0WH	460.8WH	537.6WH
	12.8V12AH	12.8V18AH	12.8V24AH	12.8V30AH	12.8V36AH	12.8V42AH
Charing Time	5.12Hrs	5.76Hrs	6.14Hrs	6.40Hrs	6.58Hrs	6.72Hrs
Battery Lifespan	>2000 times cycle					
Run Time(@full power)	15hrs / 10hrs	11.5hrs / 9hrs	10hrs / 8.5hrs	9.5hrs / 8.5hrs	9hrs	9hrs
Ambient Temperature	-10°C to 50°C (14°F to 122°F)					
Storage Temperature	-20°C to 45°C (-4°F to 113°F)					
Control System	PWM / MPPT / complementary solution, custom IOT and remote control on request					
Maximum Autonomy	Operate 5~7 rainy days under intelligent model.					
Others						
Lifespan	L90B10 - 100000 hrs, @Tq 25°C					
Warranty	3 years as standard (Warranty extension to 5 years on request)					
Certification	FCC CE RoHS, the company is ISO 9001 and ISO 14001 certified,For other certificates please request					
Product Size	594*366*252mm / 23.38*14.40*9.92 inches	754*366*252mm / 29.68*14.40*9.92 inches	910*366*252mm / 35.82*14.40*9.92 inches	1064*366*252mm / 41.89*14.40*9.92 inches	1224*366*252mm / 49.72*14.40*9.92 inches	1379*366*252mm / 54.29*14.40*9.92 inches
Net Weight	11.49kg / 25.33lbs	12.86kg / 28.35lbs	14.89kg / 32.83lbs	16.5kg / 36.38lbs	17.61kg / 38.82lbs	19.66kg / 43.34lbs
Carton Size	860*440*210mm / 33.9*17.3*8.3 inches	1020*440*210mm / 40.2*17.3*8.3 inches	1175*440*210mm / 46.3*17.3*8.3 inches	1330*440*210mm / 52.4*17.3*8.3 inches	1490*440*210mm / 58.7*17.3*8.3 inches	1645*440*210mm / 64.8*17.3*8.3 inches
Gross Weight	14.5kg / 31.97lbs	15.86kg / 34.97lbs	17.97kg / 39.62lbs	19.6kg / 43.21lbs	21.49kg / 47.38lbs	22.44kg / 49.47lbs
Recommend Installation Height	3-6m	5-7m	5-8m	6-9m	6-10m	7-12m
Application Field	Road & street, residential area, garden, parks, parking lot, industrial and commercial parks, railway & station side, riverside & jogging track					
Warranty	3 years as standard (Warranty extension to 5 years on request)					
Important Note!	The provided information is solely for reference; the official measurement report holds higher authority.					

Construction Features

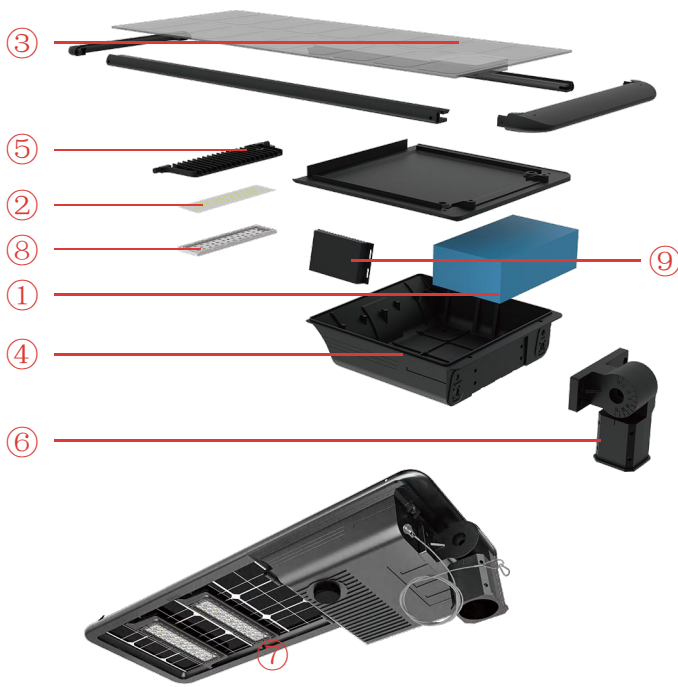

- 1- Easy battery replacement design, can be renewed for 7 years.
- 2- Ultra-high light efficiency, 10 watts equivalent to 20 watts of others at least.
- 3- Bilateral solar panels, the overall conversion efficiency is increased by 30%.
- 4- Unique anti-theft technology on battery door.
- 5- Rotatable LED module, worry-free installation, best solar panel angle adapt to the sun.
- 6- The various installation methods suit for any application likes light poles, wall surface and etc.
- 7- From 10 to 60 watts, can replace the traditional 35-240 watts, meeting all road application conditions.
- 8- Customizable optical road lighting designs, adapt to various road conditions but no waste of light.
- 9- Controller, system charging and charging intelligent control center.

Working Way

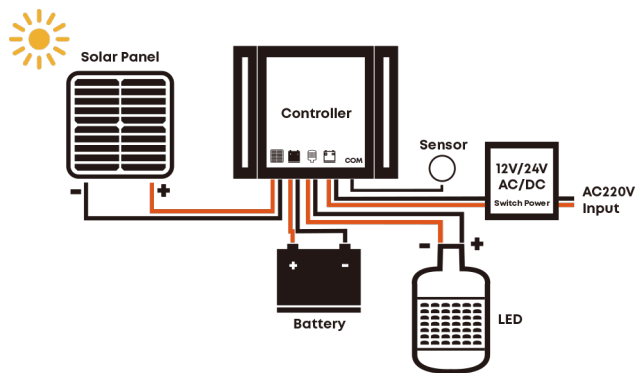

The solar panel receives solar radiation energy and converts it into electricity, which is stored in the battery by the photovoltaic controller. At night, when the illumination gradually decreases to about 10LUX and the solar panel voltage is 5V, the charge and discharge controller detects this voltage value, and controls the battery to discharge for the LEDs to complete the process of daytime charging and evening discharge. When the battery voltage is lower than the set value, the power supply will switch to mains power, and when the voltage is higher than the set value, it will switch to battery power. The standard configuration does not include mains complementary function.

Ordering Information

AOK							
WATTS	VOLTAGE	LED CHIPS	TYPE OF SENSOR	CCT&CRI	DISTRIBUTION	MOUNT	COLOR
10WSE	DC=Solar	S5=Seoul 5050	00=Without Sensor	3070=3000K 70CRI	T203 (65°*150°)	Type A	BK=Black
15WSE	NV=Grid		SN=Motion Sensor	4070=4000K 70CRI	T212 (75°*165°)	Type B	
20WSE			(up to 9M)	5070=5000K 70CRI	T304 (75°*160°)	Type C	
25WSE			PIR=PIR Sensor (up to 7M)	5770=5700K 70CRI	T402 (80°*150°)	Type D	
30WSE			DV=Dimmable	6570=6500K 70CRI	T502 (150°*150°)		
35WSE				3080=3000K 80CRI			
40WSE				4080=4000K 80CRI			
45WSE				5080=5000K 80CRI			
50WSE				5780=5700K 80CRI			
60WSE				6580=6500K 80CRI			

Accessories (Order separately)
 Intelligent APP control
 IOT Management
 AC & DC complementary

Photometry

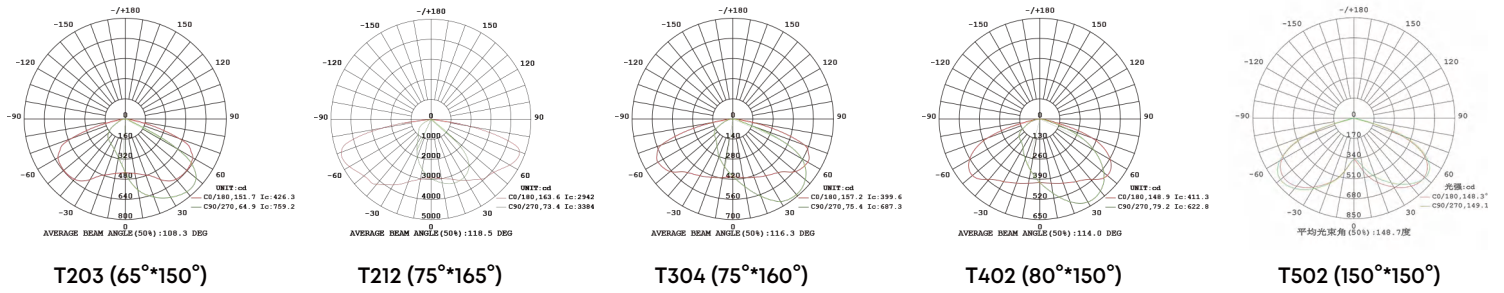

Illuminance Diagram

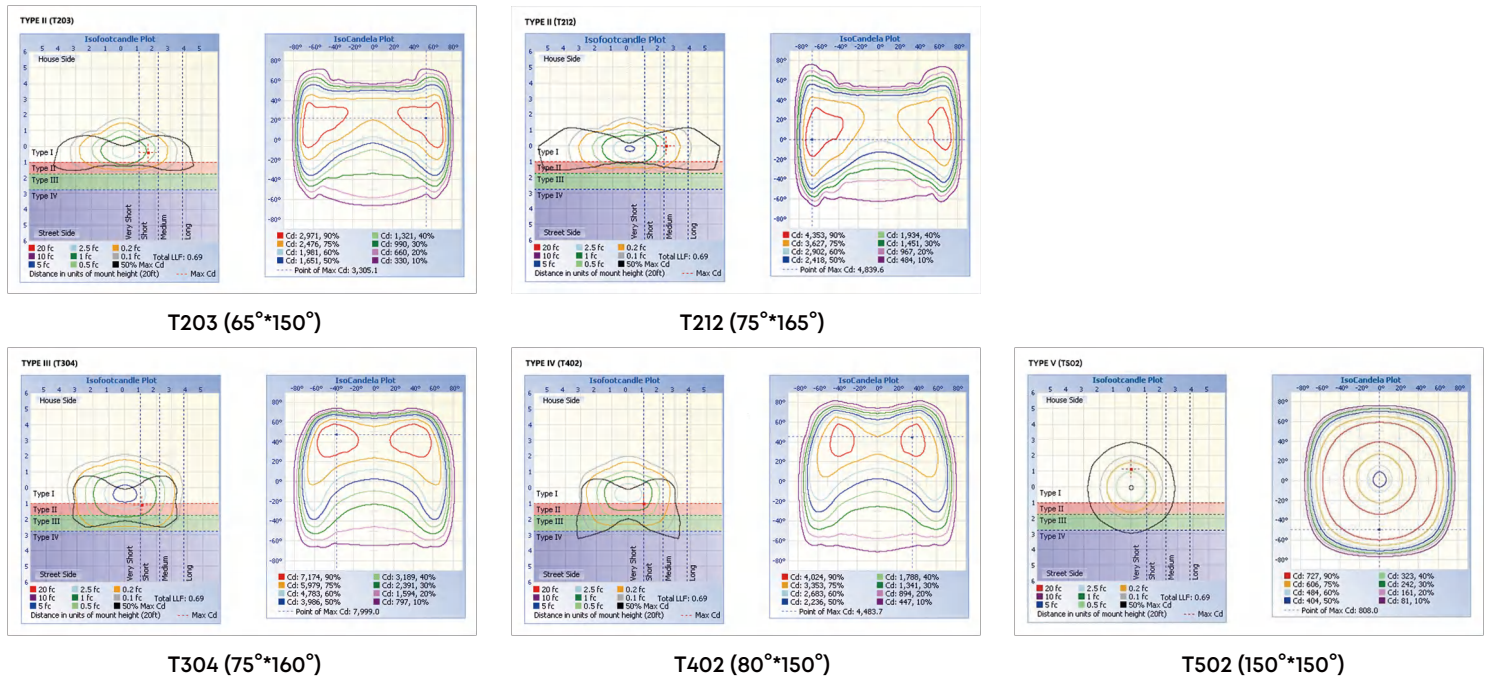

Accessories

Mounting Options



Type A
Universal Bracket

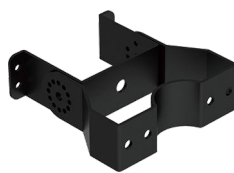

Type B
Wall Mount



Type C
Round Pole



Type D
Square Pole



Bird Spikes



PIR/microwave
Motion Sensor



Programmable
Remote Control



MPPT
4G/Zigbee-IoT



Safety Rope

*As the products are upgraded, the accessories may differ from those described in the pictures. Please consult with our sales team for updated details and order separately.

Dimensions

10W/15W

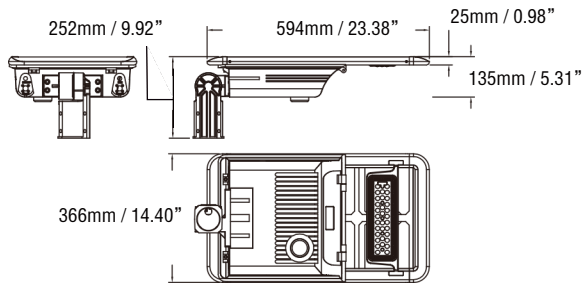

20W/25W

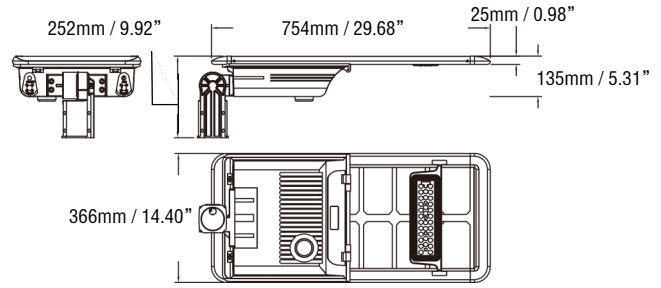

30W/35W

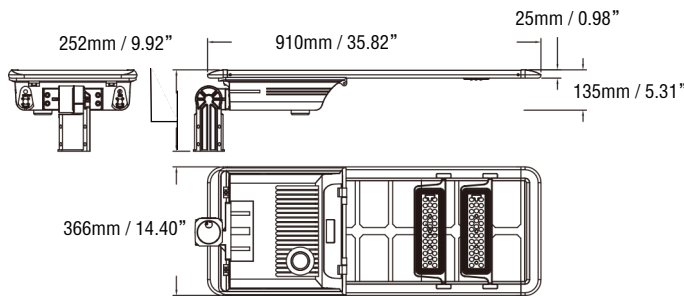

40W/45W

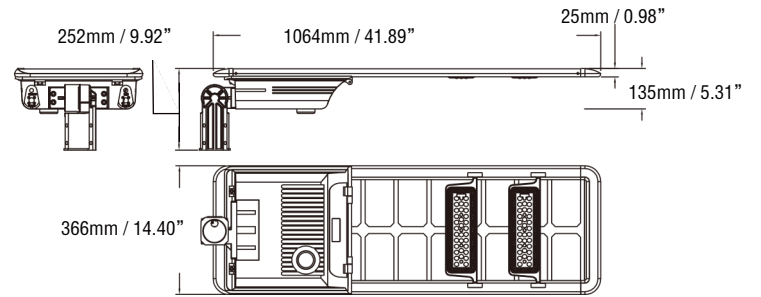

50W

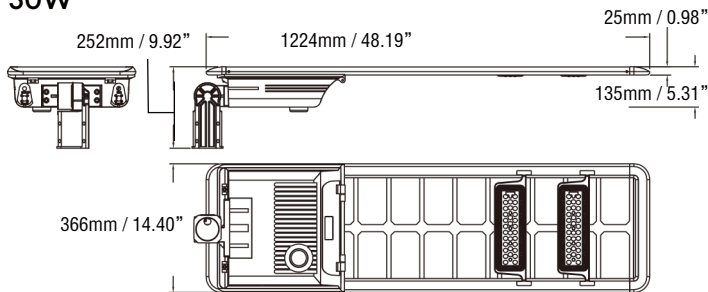

60W

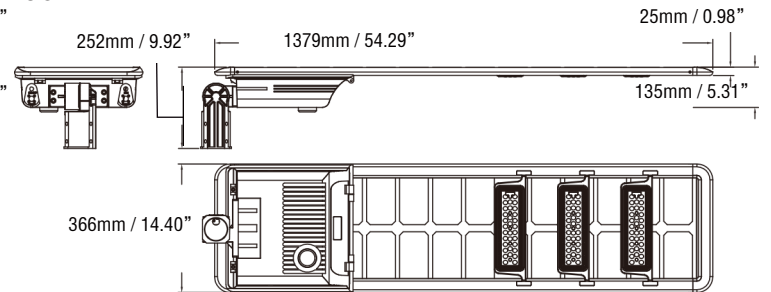



Quality, Honesty, Service and Innovation

Innovative & Tailored Lighting Solutions for **Success**



3 Year Limited Warranty,
5 Year Preferred Warranty.
Please consult with our sales for detailed agreement.

wally@aokledlight.com

www.aokledlight.com

+1 626-986-4050 (US)

+86 755 2357 9148 (CN)

Manufacturing:

Shenzhen: Building 1 & 4, St. George's Science and Technology Industrial Park, Shajing Street, Shenzhen, China, 518124.

Huizhou: Building 2, Yinghui Electronic Science and Tech Park, No. 6 Dongsheng North Rd, Chenjiang Street, Zhongkai High-tech Zone, Huizhou, China. 516006.

Fuzhou HQ: Room 301, Yujing Business Center Zone 1, No. 12 Baihuazhou road, Cangshan district, Fuzhou, China, 350007

Copyright ©2024 AOK LED LIGHT CO., LTD. All Right Reserved.