

200+ Patent Certificates
\$1,000,000+ Annual Energy Saving
20,000+ Projects Successfully Installed



PLA Series LED Area Light

Shoebox / Parking lot lighting
Power: 75W - 230W



Innovative & Tailored
Lighting Solutions for **Success**
www.aokledlight.com

Features of **PLA** Series



For others & details
please request



The **benefits** of opting PLA series



- **Professional Distribution Options**

Customized for parking lots, ensuring flawless uniformity with a BUG rating of 0.



- **Ample Inner Space**

Reserved sensor installation position, ample inner space, reserved location for convenient installation.



- **Slick Back Design**

Slick back design to reduce dust accumulation.



- **Seven Optional Installation Brackets**

Providing flexibility and convenience to meet various installation requirements.



- **Exceptional Impact Resistance**

IK09, passed 3G shock resistance test.



● **WARRANTY**

5 Year Limited Warranty,
10 Year Preferred Warranty.

Please consult with our sales for detailed agreement.

PLA series is an economical energy-saving and flexible application scenarios area light with high-cost performance. It is designed for commercial and industrial applications, providing cooler operating temperatures, brighter light and longer LED span.

- Light engine is thermally isolated from driver components for better heat dissipation, industrial-level design standard.
- Micro-lens systems produce IESNA Type III, Type IV and Type V distributions, full cutoff type, no uplight pollution.
- Luminaries produces 0% total lumens above 90 ° (BUG Rating, U=0), provides uniform light output with a lower glare.
- Optical systems maintain an IP66 rating.
- The top spot of the fixture is reserved for the sensor in the case of future installation.

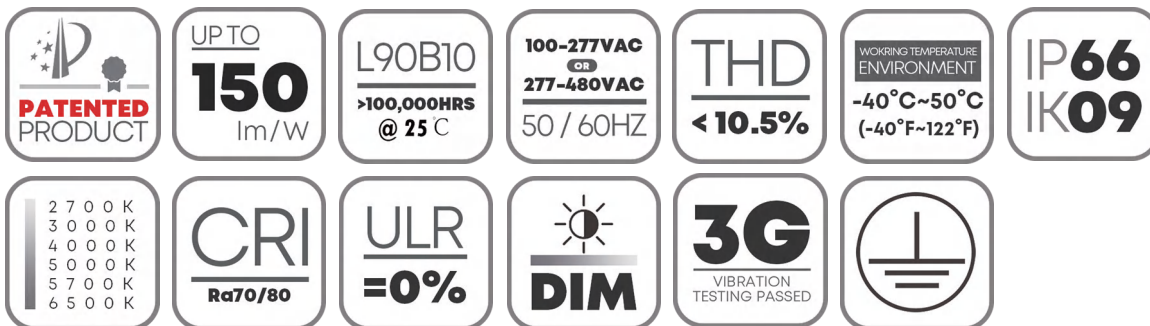

Note: Normal Voltage=100-277VAC, High Voltage=277-480VAC, please evaluate before choosing. For the power supply in the United States and Canada, in case the input voltage fluctuation $\geq 240V$ the High Voltage solution is highly recommended for performance stability. Improper selection will cause damage to the driver or the light.

wally@akledlight.com
+1 626-986-4050 (US)
+86 755 2357 9148 (CN)

©2024 AOK LED LIGHT CO., LTD. All Right Reserved.



Photometric Design

- Optimized, premium optical grade Mitsubishi polycarbonate lens, the efficient design of the modules make each light engine highly customizable, allowing the light distribution to be aimed toward the application.
- Optical systems allow for versatility, tight cutoffs, and flexible control for a wide variety of applications.
- We deliver innovation and customization, further expanding the flexibility of the project. Exceptional uniformity and low glare for maximum comfort and neighbor-friendly.

Distribution Type

T301 (70W-150W)

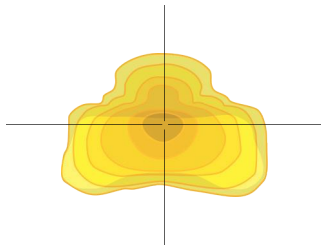

Asymmetric, Type III can be used in wide road parking areas, or at corner areas.

T302 (70W-150W)

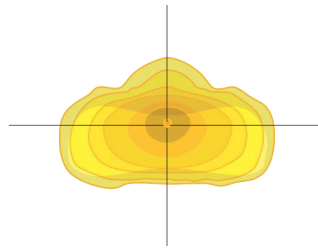

Asymmetric, Type III can be used in wide road parking areas, or at corner areas.

T402 (70W-150W)

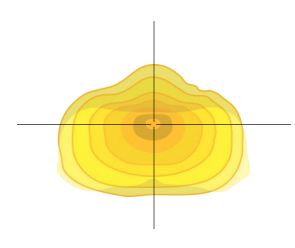

Asymmetric, Type IV can be used in wide road parking areas, or at corner areas.

T501 (70W-150W)

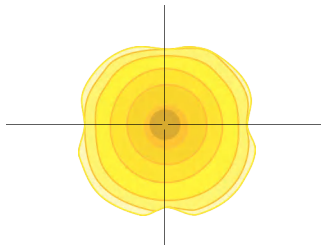

Symmetrical, T5 is suitable for use in the central area of the car park, or in road intersection areas

T502 (70W-150W)

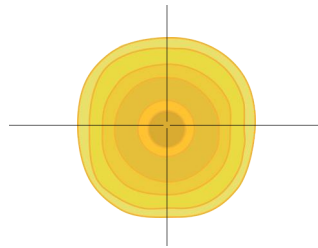

Symmetrical, T5 is suitable for use in the central area of the car park, or in road intersection areas

T301 (200W-230W)

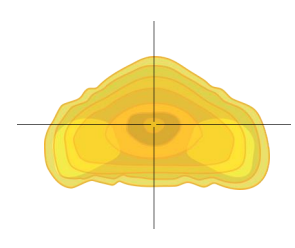

Asymmetric, Type III can be used in wide road parking areas, or at corner areas.

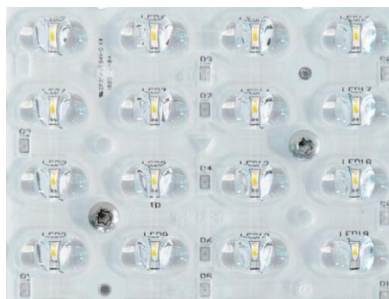
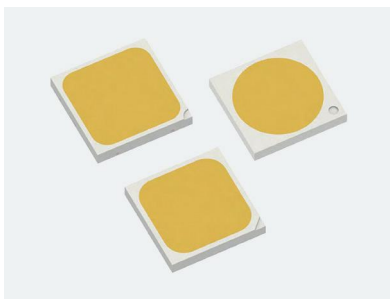

- The photometric engine takes advantage of the latest generation of mid/high-power LEDs and dedicated optics for professional applications.
- With 3030 or 5050 LED chips, it provides an alternative solution for those who are looking for very cost-effective yet efficient lighting while keeping the same luminaire design.

Flexible Installation

• Up to 7 installation methods (brackets) can be suitable for different installation scenarios, quickly adapt to the needs of the project. Convenient and **Flexible**.



Type A
Slipfitter
(Φ40mm)



Type A
Slipfitter
(Φ60mm)

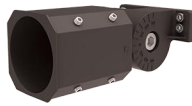

Type A
Slipfitter
(Φ76mm)



Type B
Adjustable
Arm Mount



Type C
Yoke Mount



Type D
Side & Lock
Mount



Type E
Square Pole
Mount



Type F
Round Pole
Mount



Type G
Trunnion
Mount

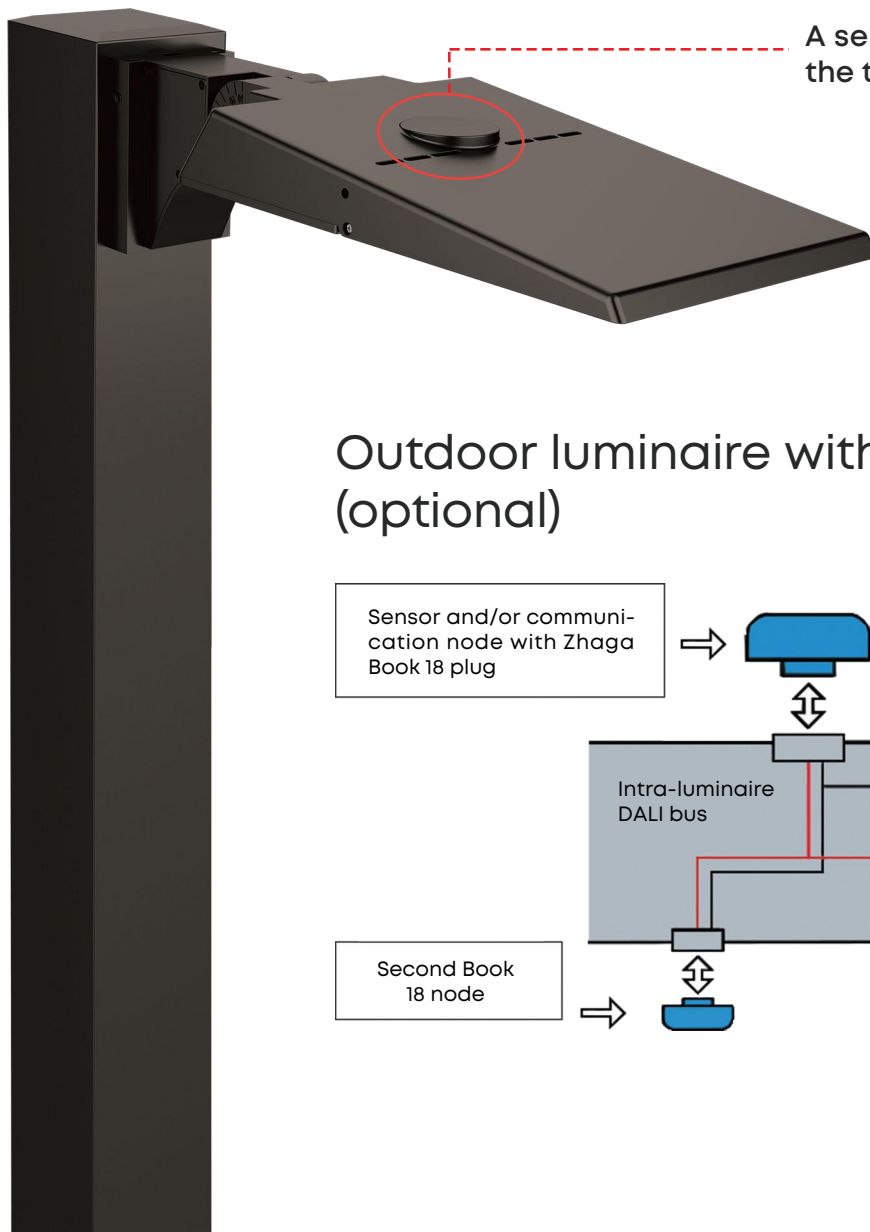

A sensor mounting hole is reserved on the top to facilitate future installation.

Outdoor luminaire with Zhaga receptacles (optional)

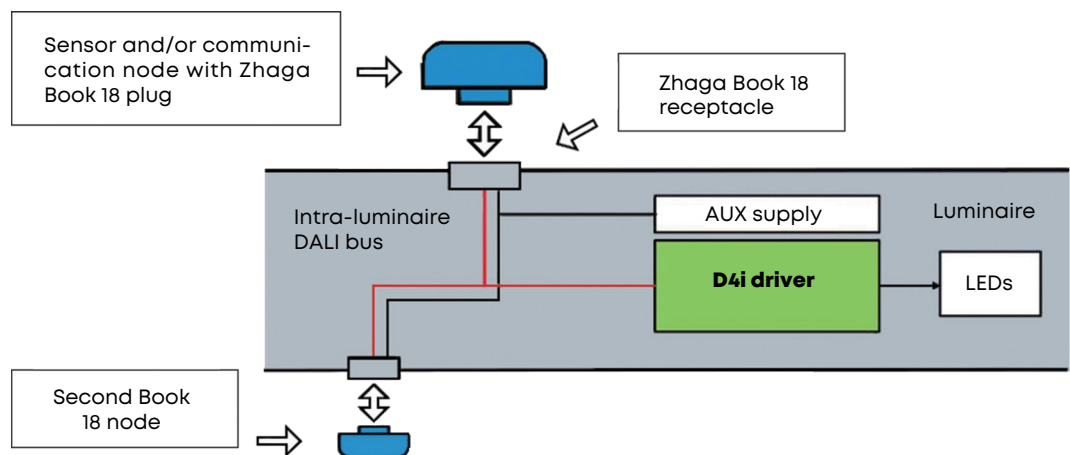

7

Custom Dimming Profile

Intelligent luminaire drivers can be programmed with complex dimming profiles. With customized combinations of time intervals and light levels are possible. This feature does not require any extra wiring.

The period between switching on and switching off is used to activate the preset dimming profile. The customised dimming system generates maximum energy savings while respecting the required lighting levels and uniformity throughout the night.

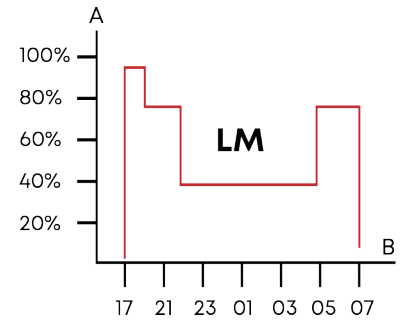

Daylight Sensor / Photocell

Photocell or daylight sensors switch the luminaire on as soon natural light falls to a certain level. It can be programmed to switch on during a storm, on a cloudy day (in critical areas) or only at night-fall so as to provide safety and comfort in public spaces.

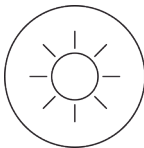

2

3

Motion Detection

In places with little nocturnal activity, lighting can be dimmed to a minimum most of the time. By using passive infrared (PIR) or Microwave sensors, the level of light can be raised as soon as a pedestrian or a slow vehicle is detected in the area.



Each luminaire level can be configured individually with several parameters such as minimum and maximum light output, delay period and ON/OFF duration time. Motion sensors can be used in an autonomous or interoperable network.

Application Reference

- Urban & residential streets
- Bridges
- Bike & pedestrian paths
- Railway stations & metros
- Car parks
- Squares & pedestrian areas
- Roads & motorways

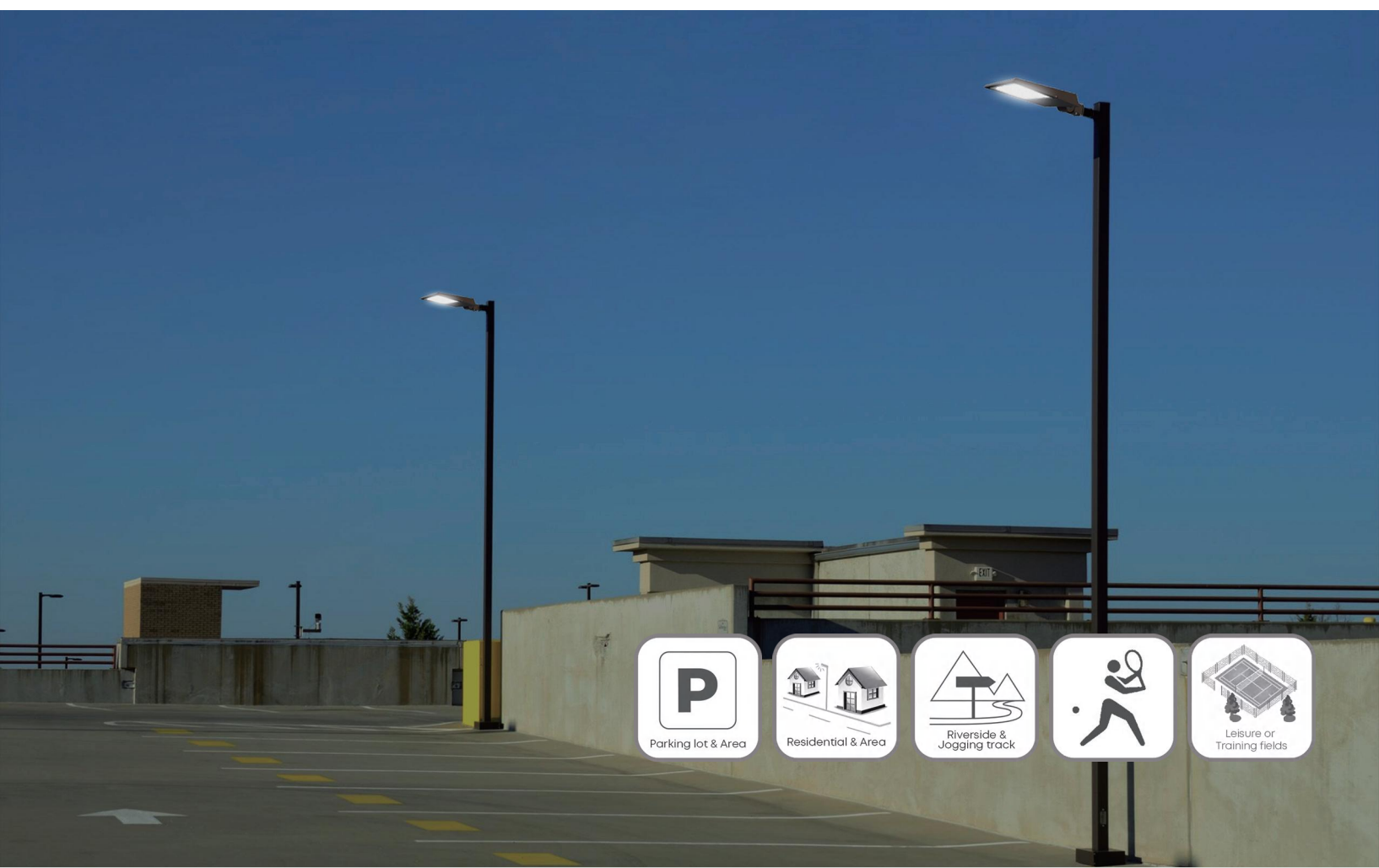

Parameter Table

Electrical Data						
Model	AOK-75WPLA	AOK-100WPLA	AOK-150WPLA	AOK-200WPLA	AOK-230WPLA	
Power(w)	75W	100W	150W	200W	230W	
Input Voltage	Normal Voltage=100-277VAC, High Voltage=277-480VAC, please read *Note-1 before choosing.					
THD	<10.5%					
PF	> 0.95	> 0.95	> 0.95	> 0.95	> 0.95	
Driver Efficiency	90%	91%	92%	92%	93%	
Maximum Current	AC0.85A	AC1.13A	AC1.7A	AC2.26A	AC2.6A	
Control Option	Driver includes wiring for 0-10V dimming systems. Dim as low as 10%.					
Operating Temperature	-40°C to 50°C (-40 °F to 122 °F)					
Surge Protection	10kV / 20kV optional					
Photometric Data						
Efficacy (lm/W, Std Dev ±5%)@CRI 70Ra, 5000K-2835-T301	150lm/W	150lm/W	145lm/W	150lm/W	145lm/W	
Luminous Flux(lm, Std Dev ±5%) @CRI 70Ra, 5000K-2835-T301	11250lm	15000lm	21750lm	30000lm	33350lm	
CCT	2700K, 3000K, 4000K, 5000K, 5700K, 6500K					
CRI	Ra70,Ra80,Ra90					
LED Model	2835 ,3030, 5050			2835 ,3030		
Lens	Polycarbonate					
Beam Angle	T301 (80°150°),T302 (80°155°),T402 (80°150°),T501 (155°155°),T502 (160°160°)			T301 (70°150°)		
Mechanical Data						
IP/IK Rating	IP66/IK09, according to standard EN 60529 and EN 62262					
Vibration Resistance	3G, conform to standard IEC 68-2-6					
EPA(SCx), Fixture Body	Side: 1.86ft²(0.1728m²); Top: 11.90ft²(1.1055m²)			Side: 2.31ft²(0.2144m²); Top: 16.97ft²(1.5764m²)		
Housing	Heavy-duty die-cast aluminum (EN AC-46100)					
Heat Radiator	Aluminum alloy					
Surface Treatment	Anti-UV thermosetting polyester / Anti-UV thermosetting polyester (for extremely corrosive environments).					
Painting	Black, Customized color					
Cable	Pre-wired with a 30 cm cable (Other lengths on request)					
Mounting	Slip fitter(Φ40/60/76mm)/Arm mount/Yoke mount/Slide & lock/Square pole/Round pole/Trunnion					
Other Data						
Lifespan	L90B10 - 100000 hrs, @Tq 25°C					
Warranty	5 years in standard, 10 years optional					
Certification	UL,DLC5.1,FCC					
Product Size	A-Slipfitter	L573.2*W256*H79.2mm / 22.57*10.08*3.12 "		L668.5*W295*H79.4mm / 26.32*11.61*3.13 "		
	B-Adjustable Arm	L590*W256*H159.3mm / 23.23*10.08*6.27 "		L685.3*W295*H159.5mm / 26.98*11.61*6.28 "		
	C-Yoke Mount	L443.7*W256*H59.2mm / 17.47*10.08*2.33 "		L540*W295*H60.2mm / 21.26*11.61*2.37 "		
	D-Slide Lock Mount	L549.3*W256*H162.5mm / 21.62*10.08*6.4 "		L644.6*W295*H162.7mm / 25.38*11.61*6.41 "		
	E-Square Pole	L558.3*W256*H150mm / 21.98*10.08*5.91 "		L653.6*W295*H150mm / 25.73*11.61*5.91 "		
	F-Round Pole	L580.7*W256*H150mm / 22.86*10.08*5.91 "		L676.1*W295*H150mm / 26.62*11.61*5.91 "		
	G-Trunnion Mount	L567.3*W256*H70mm / 22.33*10.08*2.76 "		L662.6*W295*H70mm / 26.09*11.61*2.76 "		
Net Weight	A-Slipfitter	4.41kg / 9.72 lbs	4.41kg / 9.72 lbs	4.54kg / 10.01 lbs	6.25kg / 13.78 lbs	6.37kg / 14.04 lbs
	B-Adjustable Arm	5kg / 11.02 lbs	5kg / 11.02 lbs	5.12kg / 11.29 lbs	6.8kg / 15.0 lbs	6.92kg / 15.26 lbs
	C-Yoke Mount	4.17kg / 9.19 lbs	4.17kg / 9.19 lbs	4.3kg / 9.48 lbs	6.08kg / 13.4 lbs	6.2kg / 13.67 lbs
	D-Slide Lock Mount	4.57kg / 10.08 lbs	4.57kg / 10.08 lbs	4.7kg / 10.36 lbs	6.2kg / 13.67 lbs	6.32kg / 13.93 lbs
	E-Square Pole	4.22kg / 9.30 lbs	4.22kg / 9.30 lbs	4.35kg / 9.59 lbs	6.08kg / 13.4 lbs	6.2kg / 13.67 lbs
	F-Round Pole	4.77kg / 10.52 lbs	4.77kg / 10.52 lbs	4.9kg / 10.80 lbs	6.4kg / 14.11 lbs	6.52kg / 14.37 lbs
	G-Trunnion Mount	4.73kg / 10.43 lbs	4.73kg / 10.43 lbs	4.86kg / 10.71 lbs	6.54kg / 14.42 lbs	6.66kg / 14.68 lbs
Carton Size	A-Slipfitter	L660*W280*H90mm / 25.98*11*3.54 "		L775*W320*H90mm / 30.5*12.6*3.54 "		
	B-Adjustable Arm	L678*W228*H180mm / 26.69*8.97*7.08 "		L775*W320*H175mm / 30.5*12.6*6.88 "		
	C-Yoke Mount	L546*W296*H90mm / 21.49*11.65*3.54 "		L642*W335*H90mm / 25.27*13.18*3.54 "		
	D-Slide Lock Mount	L644*W228*H180mm / 25.35*8.97*7.08 "		L740*W320*H175mm / 29.1*12.6*6.88 "		
	E-Square Pole	L665*W280*H180mm / 26.18*10.8*7.08 "		L760*W320*H180mm / 29.92*12.6*7.08 "		
	F-Round Pole	L665*W280*H180mm / 26.18*10.8*7.08 "		L760*W320*H180mm / 29.92*12.6*7.08 "		
	G-Trunnion Mount	L660*W280*H97mm / 25.98*11.02*3.81 "		L760*W320*H100mm / 29.9*12.6*3.93 "		
Gross Weight	A-Slipfitter	4.77kg / 10.52 lbs	4.77kg / 10.52 lbs	4.9kg / 10.80 lbs	6.62kg / 14.59 lbs	6.74kg / 14.86 lbs
	B-Adjustable Arm	5.7kg / 12.57 lbs	5.7kg / 12.57 lbs	6.03kg / 13.29 lbs	7.8kg / 17.20 lbs	7.92kg / 17.46 lbs
	C-Yoke Mount	4.54kg / 10.01 lbs	4.54kg / 10.01 lbs	4.67kg / 10.30 lbs	6.72kg / 14.82 lbs	6.84kg / 15.08 lbs
	D-Slide Lock Mount	5.37kg / 11.84 lbs	5.37kg / 11.84 lbs	5.5kg / 12.13 lbs	7.2kg / 15.87 lbs	7.32kg / 16.14 lbs
	E-Square Pole	5.22kg / 11.51 lbs	5.22kg / 11.51 lbs	5.35kg / 11.79 lbs	7.08kg / 15.61 lbs	7.2kg / 15.87 lbs
	F-Round Pole	5.6kg / 12.35 lbs	5.6kg / 12.35 lbs	5.72kg / 12.61 lbs	7.4kg / 16.31 lbs	7.52kg / 16.58 lbs
	G-Trunnion Mount	5.13kg / 11.31 lbs	5.13kg / 11.31 lbs	5.26kg / 11.60 lbs	6.94kg / 15.30 lbs	7.06kg / 15.56 lbs
Important Note!	The provided information is solely for reference; the official measurement report holds higher authority.					

* Note-1: For the power supply in the United States and Canada, in case the input voltage fluctuation ≥240V the High Voltage solution is highly recommended for performance stability. Improper selection will cause damage to the driver or the light.

Ordering Information

AOK								
WATTS	VOLTAGE	LED CHIPS	TYPE OF SENSOR	CCT&CRI	DISTRIBUTION	MOUNT	HOUSING	OPTIONS
75WPLA	NV=100-277V	L2=2835	00=Without Sensor	2770=2700K 70CRI	(70W-150W)	A=Slipfitter	BK=Black	10KV SPD
100WPLA	HV=277-480V	L3=3030	PH=Photocell	3070=3000K 70CRI	T301 (80°150°)	B=Adjustable	BZ=Bronze	20KV SPD
150WPLA		L5=5050	DV=Dimmable	4070=4000K 70CRI	T302 (80°155°)	C=Yoke	WH=White	DIP Switch
200WPLA			PIR=PIR sensor	5070=5000K 70CRI	T402 (80°150°)	D=Slide & Lock	SI=Silver	
230WPLA				5770=5700K 70CRI	T501 (155°155°)	E=Square Pole	RD=Red	
				6570=6500K 70CRI	T502 (160°160°)	F=Round Pole	BL=Blue	
				2780=2700K 80CRI	(200W-230W)	G=Trunnion		
				3080=3000K 80CRI	T301 (70°150°)			
				4080=4000K 80CRI				
				5080=5000K 80CRI				
				5780=5700K 80CRI				
				6580=6500K 80CRI				

Photometry & Illuminance Diagram

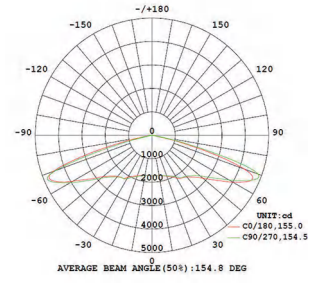
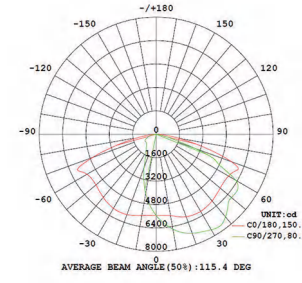
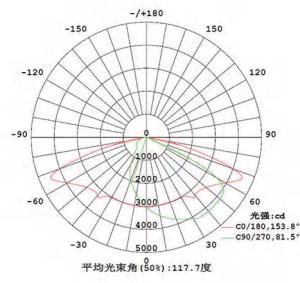
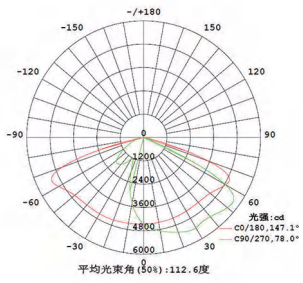

T301(80°150°) (70W-150W)

T302(80°155°) (70W-150W)

T402(80°150°) (70W-150W)

T501(155°155°) (70W-150W)

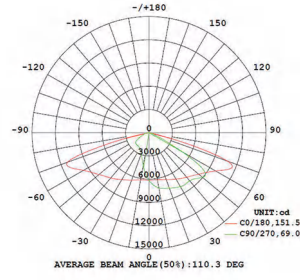
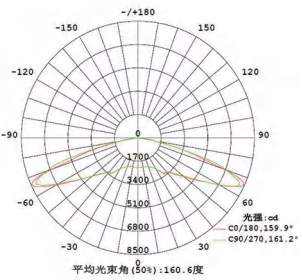

T502(160°160°) (70W-150W)

T301(70°150°) (200W-230W)

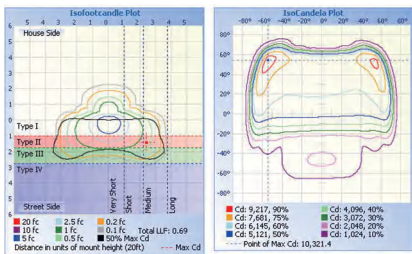

T301(80°150°) (70W-150W)

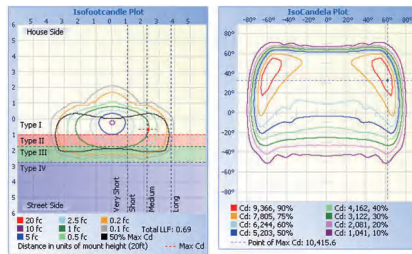

T302(80°155°) (70W-150W)

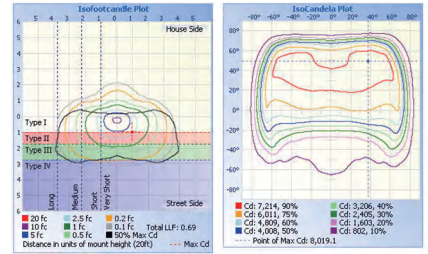

T402(80°150°) (70W-150W)

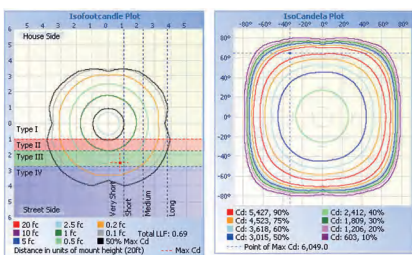

T501(155°155°) (70W-150W)

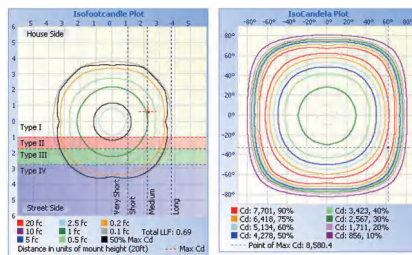

T502(160°160°) (70W-150W)

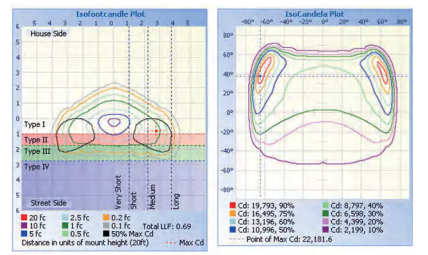

T301(70°150°) (200W-230W)

Dimensions

Type-A Slip Fitter

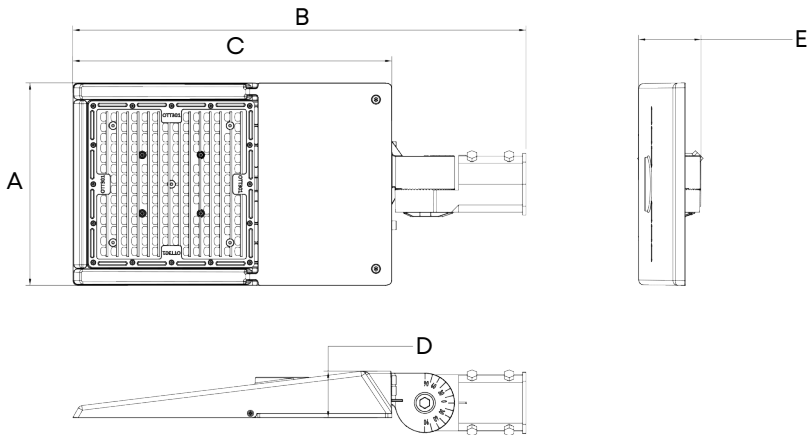

	A	B	C
75W-150W	255.96mm 10.08"	573.16mm 22.57"	403.6mm 15.89"
200W-230W	294.97mm 11.61"	668.54mm 26.32"	498.97mm 19.64"
	D	E	
75W-150W	59.21mm 2.33"	79.19mm 3.12"	
200W-230W	60.16mm 2.37"	79.39mm 3.13"	

Type-B Adjustable Arm

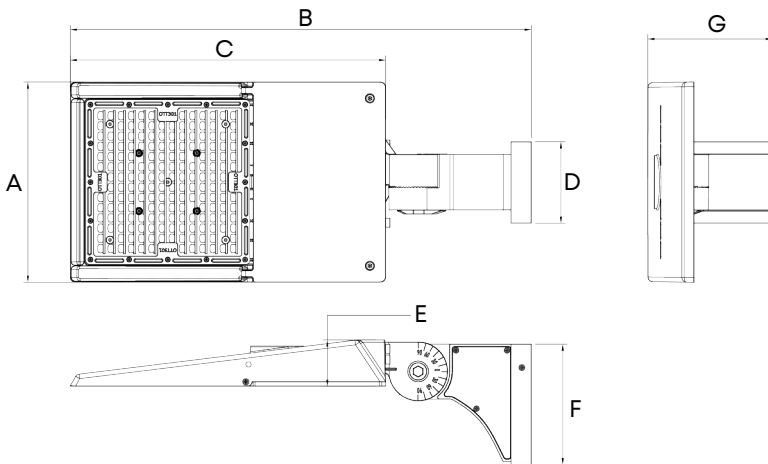

	A	B	C	
75W-150W	255.96mm 10.08"	589.99mm 23.23"	403.6mm 15.89"	
200W-230W	294.97mm 11.61"	685.34mm 26.98"	498.97mm 19.64"	
	D	E	F	G
75W-150W	104mm 4.09"	59.21mm 2.33"	154mm 6.06"	154mm 6.27"
200W-230W	104mm 4.09"	60.16mm 2.37"	154mm 6.06"	159.45mm 6.28"

Type-C Yoke

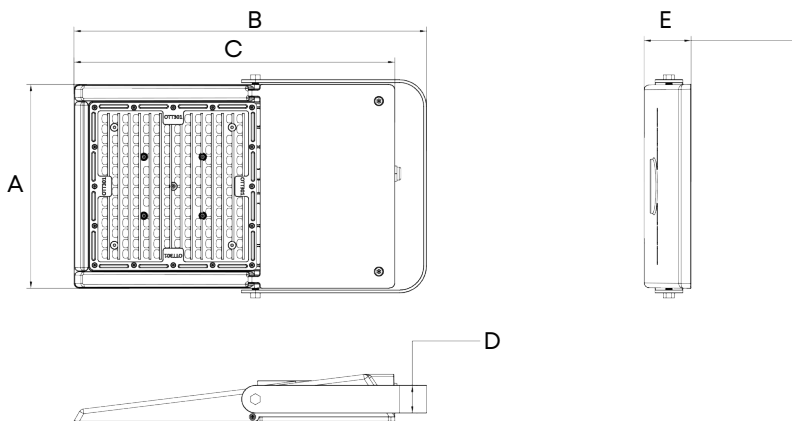

	A	B	C
75W-150W	255.96mm 10.08"	443.65mm 17.47"	403.6mm 15.89"
200W-300W	294.97mm 11.61"	539.98mm 21.26"	498.97mm 19.64"
	D	E	
75W-150W	35mm 1.38"	59.19mm 2.33"	
200W-230W	35mm 1.38"	60.16mm 2.37"	

Type-D Slide Lock Mount

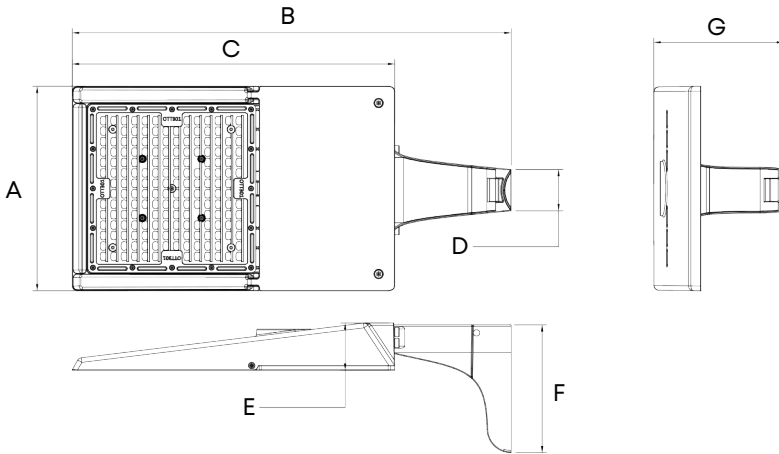

	A	B	C	
75W-150W	255.96mm 10.08"	549.25mm 21.62"	403.6mm 15.89"	
200W-230W	294.97mm 11.61"	644.6mm 25.38"	498.97mm 19.64"	
	D	E	F	G
75W-150W	51.87mm 2.04"	59.21mm 2.33"	160mm 6.3"	162.46mm 6.4"
200W-230W	51.87mm 2.04"	60.16mm 2.37"	160mm 6.3"	162.7mm 6.41"

Type-E Square Pole

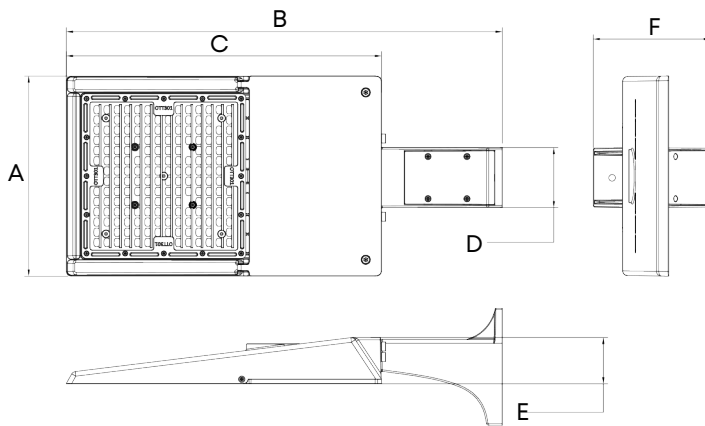

	A	B	C
75W-150W	255.96mm 10.08"	558.25mm 21.98"	403.6mm 15.89"
200W-230W	294.97mm 11.61"	653.6mm 25.73"	498.97mm 19.64"
	D	E	F
75W-150W	77mm 3.03"	59.21mm 2.33"	150mm 5.91"
200W-230W	77mm 3.03"	60.16mm 2.37"	150mm 5.91"

Type-F Round Pole

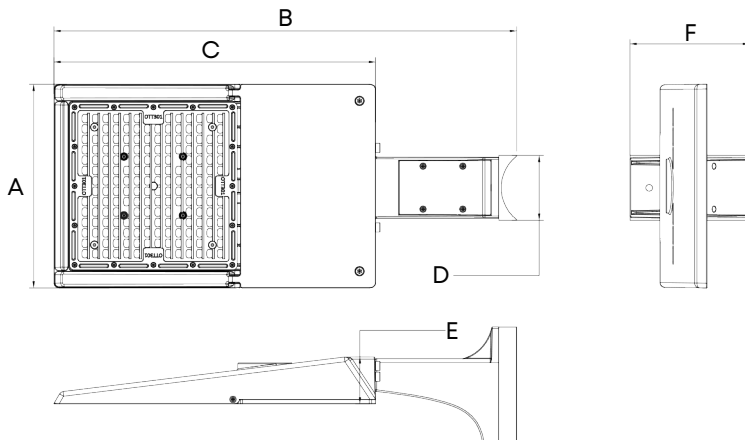

	A	B	C
75W-150W	255.96mm 10.08"	580.72mm 22.86"	403.6mm 15.89"
200W-230W	294.97mm 11.61"	676.06mm 26.62"	498.97mm 19.64"
	D	E	F
75W-150W	81.65mm 3.21"	59.21mm 2.33"	150mm 5.91"
200W-230W	81.65mm 3.21"	60.16mm 2.37"	150mm 5.91"

Type-G Trunnion

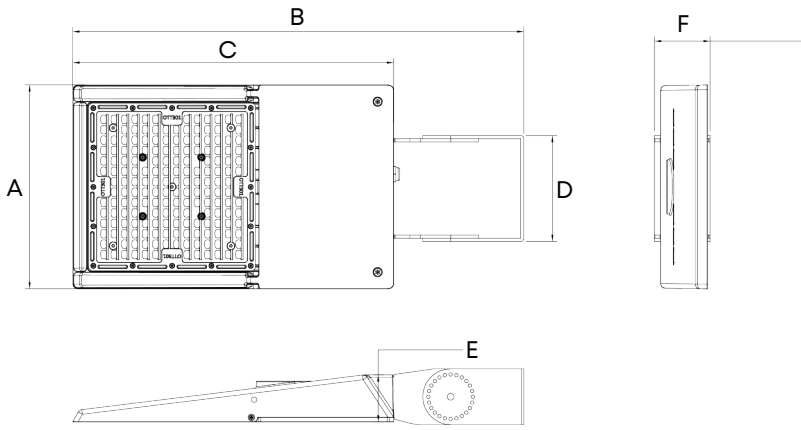

	A	B	C
75W-150W	255.96mm 10.08"	567.25mm 22.33"	403.6mm 15.89"
200W-300W	294.97mm 11.61"	662.58mm 26.09"	498.97mm 19.64"
	D	E	F
75W-150W	133mm 3.03"	59.21mm 2.33"	70mm 2.76"
200W-300W	133mm 3.03"	60.16mm 2.37"	70mm 2.76"

Accessories

Photocell



Shorting cap



3 pin/7 pin receptacle



PIR sensor



Timing control



Mounting Options



Type A
Slipfitter



Type B
Adjustable
Arm Mount



Type C
Yoke Mount



Type D
Slide & Lock
Mount



Type E
Square Pole
Mount



Type F
Round Pole
Mount



Type G
Trunnion
Mount

C- bracket standard material: SPCC.

The bracket may rust if used for an extended period, but it does not affect the lifespan of the light fixture itself. If there are specific requirements (whether it's regarding the material or the shape), please specify them before placing an order.

Other Accessories

Quick connection terminal

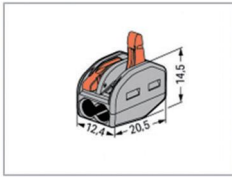

Ratings per IEC/EN
 Ratings per EN 60664
 Nominal voltage (II/2): 400V
 Rated surge voltage (II/2): 4 kV
 Ambient temperature (operation): +40 °C
 Continuous operating temperature: 85 °C
 Rated current: 32A
 Legend (ratings): (II / 2) Overvoltage category II / Pollution degree 2

Tool-less Waterproof Connector (2-pin/3-pin/4-pin optional)

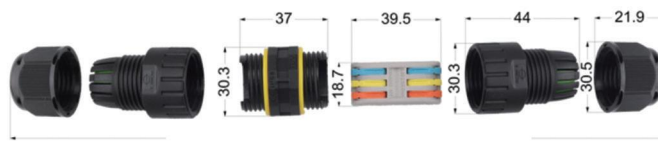

IP rating: IP68
 Rated voltage/current: 400V/24A
 Test voltage: 2500VAC
 Square number of applicable line: 0.5-2.5mm²
 Working temperature: -40~+105°C

Unit: mm. Total length of assembly: 108 (REF)

Thread clamp silicone

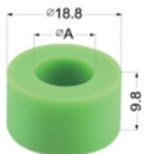

Wiring range
 A=Ø14, cable Ø: 10~14mm
 A=Ø12, cable Ø: 9~12mm
 A=Ø8.5, cable Ø: 5~9mm

*As the products are upgraded, the accessories may differ from those described in the pictures. Please consult with our sales team for updated details and order separately.



Quality, Honesty, Service and Innovation

Innovative & Tailored Lighting Solutions for **Success**



5 Year Limited Warranty,
10 Year Preferred Warranty.
Please consult with our sales for detailed agreement.

wally@aokledlight.com

www.aokledlight.com

+1 626-986-4050 (US)

+86 755 2357 9148 (CN)

Manufacturing:

Shenzhen: Building 1 & 4, St. George's Science and Technology Industrial Park, Shajing Street, Shenzhen, China, 518124.

Huizhou: Building 2, Yinghui Electronic Science and Tech Park, No. 6 Dongsheng North Rd, Chenjiang Street, Zhongkai High-tech Zone, Huizhou, China. 516006.

Fuzhou HQ: Room 301, Yujing Business Center Zone 1, No. 12 Baihuazhou road, Cangshan district, Fuzhou, China, 350007

Copyright ©2024 AOK LED LIGHT CO., LTD. All Right Reserved.