

200+ Patent Certificates
\$1,000,000+ Annual Energy Saving
20,000+ Projects Successfully Installed



OT Series LED Tennis Light

Power: 230W - 420W



Innovative & Tailored
Lighting Solutions for **Success**
www.aokledlight.com







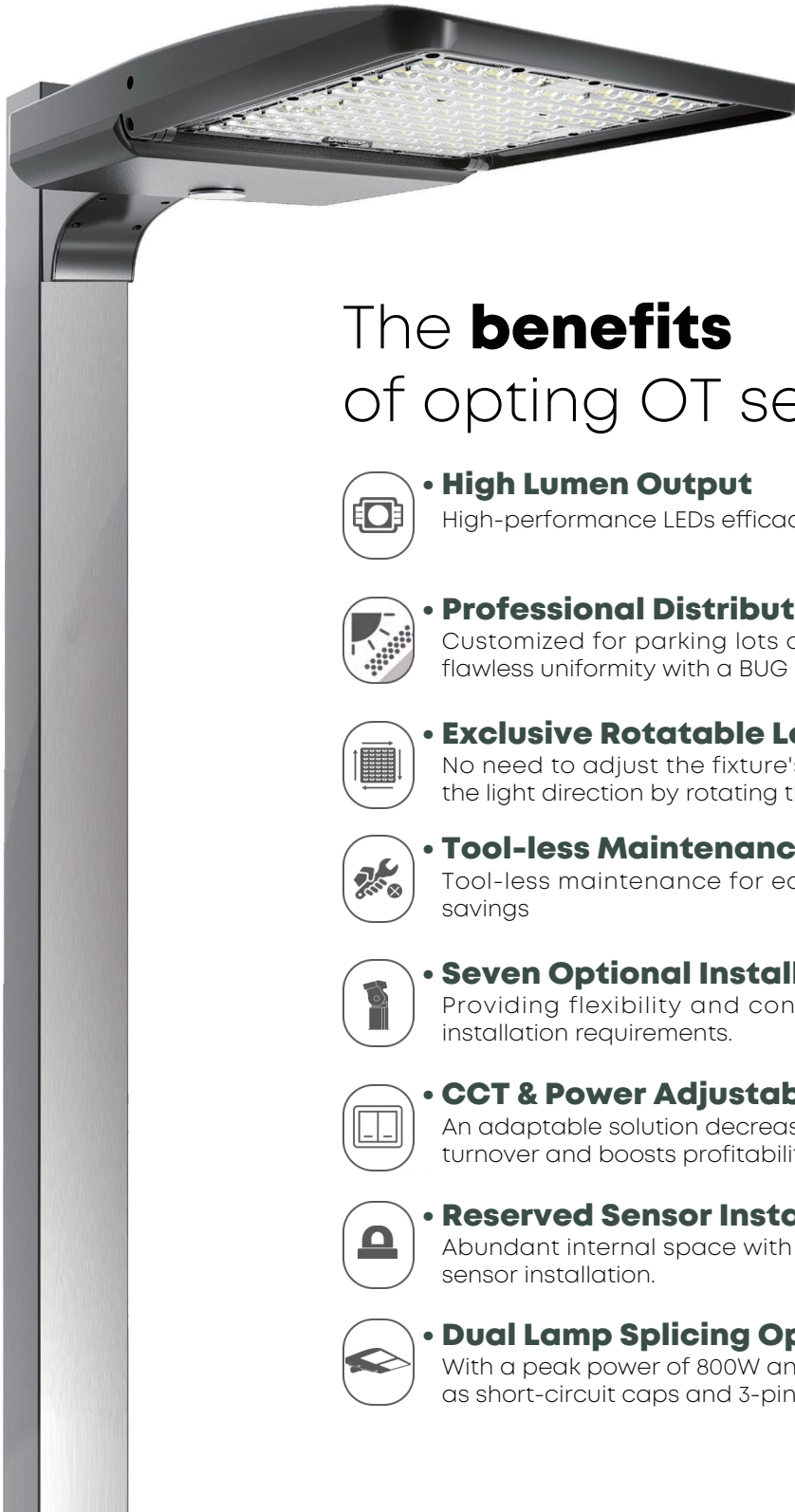

Features of **OT** Series



For others & details please request



The **benefits** of opting OT series

-  • **High Lumen Output**
High-performance LEDs efficacy up to 175lm/W,
-  • **Professional Distribution Options**
Customized for parking lots and tennis courts, ensuring flawless uniformity with a BUG rating of 0.
-  • **Exclusive Rotatable Lens design**
No need to adjust the fixture's position; you can change the light direction by rotating the lens.
-  • **Tool-less Maintenance**
Tool-less maintenance for easy maintenance and cost savings
-  • **Seven Optional Installation Brackets**
Providing flexibility and convenience to meet various installation requirements.
-  • **CCT & Power Adjustable Optional**
An adaptable solution decreases the SKUs, enhances turnover and boosts profitability.
-  • **Reserved Sensor Installation Positions**
Abundant internal space with reserved locations for easy sensor installation.
-  • **Dual Lamp Splicing Option Available**
With a peak power of 800W and optional accessories such as short-circuit caps and 3-pin/7-pin smart control bases.



WARRANTY

5 Year Limited Warranty,
10 Year Preferred Warranty.
Please consult with our sales for detailed agreement.

OT LED sports light are a game changer for court lighting applications. The low profile OT series utilizes high performance LEDs and precise optics to produce superior levels of illumination and uniformity. Compared with typical HID court lighting systems, the energy load is reduced by 50%.

- High Performance, full cutoff LED.
- More than 50% Energy Reduction vs. 1000W Metal Halide.
- L90B10>100,000 hours expected life.
- Direct retrofit mounting.
- Matching poles & brackets available.
- Light weight for easy installation (23 lbs.).
- Consistent lumen output over fixture life.
- Instant on and dimmable
- Optional wireless control available.
- Standard 5-Years warranty.
- Built-in surge protection.
- Photometric tested in accordance with IESNA standards.

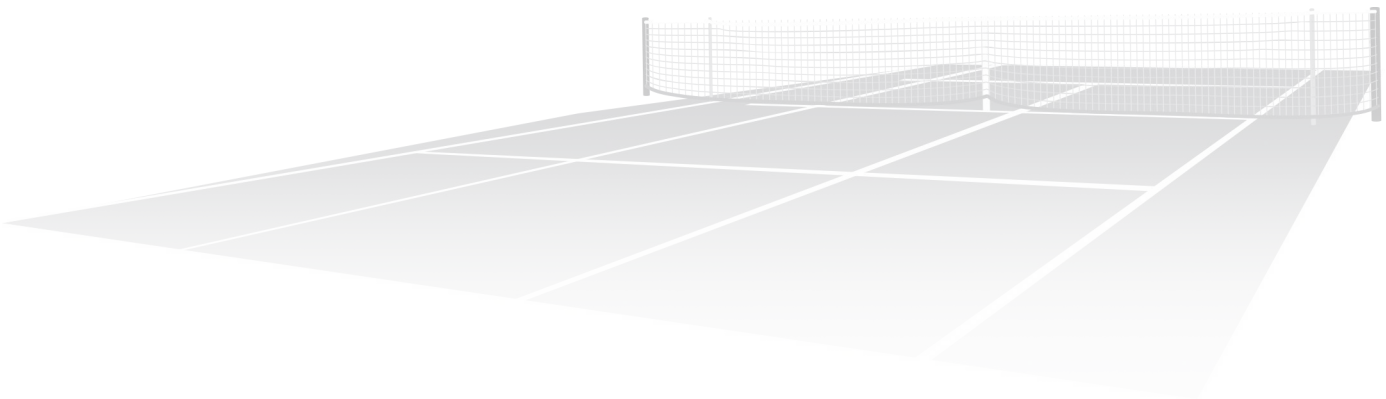

UP TO 175 lm/W	IP66 IK10	CRI Ra70/80/90	 DIM	ULR =0%	L90B10 >100,000HRS @ 25°C
 TOOL-LESS MAINTENANCE	3000K 4000K 5000K 5700K 6500K	100-277VAC OR 277-480VAC 50 / 60HZ	WORKING TEMPERATURE ENVIRONMENT -40°C~50°C (-40°F~122°F)	THD <18%	

Note: Normal Voltage=100-277VAC, High Voltage=277-480VAC, please evaluate before choosing. For the power supply in the United States and Canada, in case the input voltage fluctuation $\geq 240V$ the High Voltage solution is highly recommended for performance stability. Improper selection will cause damage to the driver or the light.

Explore the **Flexibility**

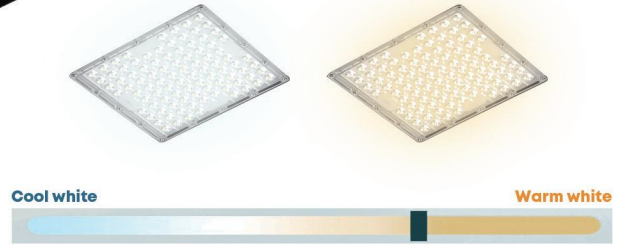

why should be **flexible with *Light***

- A colder white light optimizes performance while a warmer one is more favorable to people and animal natural cycles. What if the light can be flexible? The OT **Dual LEDs CCT adjustable solution** offers you the choice to use the right color temperature at any time. Whether it relies on preprogrammed scenarios, uses sensors or a mix of all, the CCT adjustable solution offers you the flexibility to provide the right level with the right color temperature at the right place and the right time.
- With using two types of LEDs (e.a. 3000K and 5000K), you can select one of the two color temperatures or mix both at various levels (dimming) to create a palette of color temperatures.
- As lenses cover the complete LED, the light distribution remains unchanged whatever you select.



Photometric Design

Accurate light distribution design, **Flexible** to match the project requirements:

T301(85*145°)

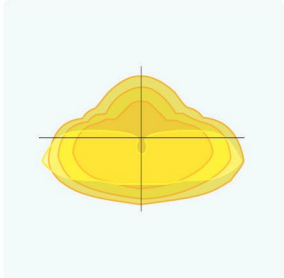

T302(80*155°)

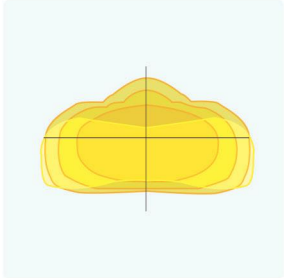

T312(60*120°)

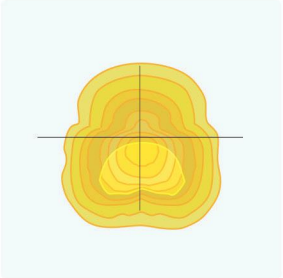

T322(50*80°)

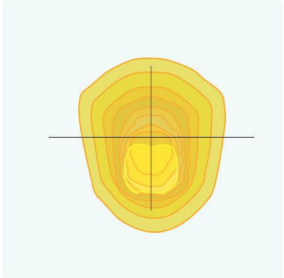

T401(70*125°)

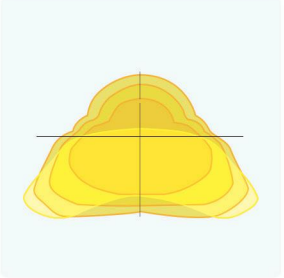

T402(90*150°)

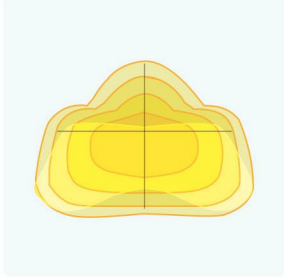

T501(150°)

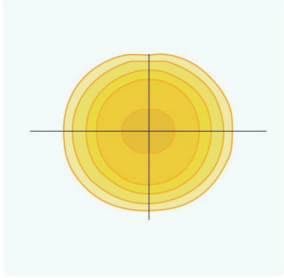

T502(160°)

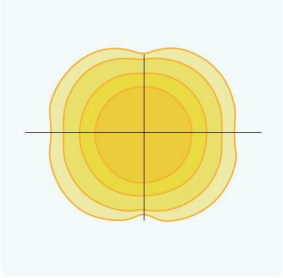

T512(150°)

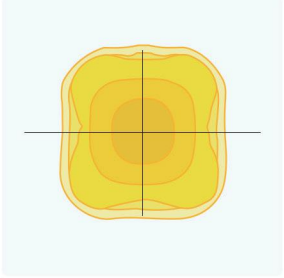

Project Simulation Effect

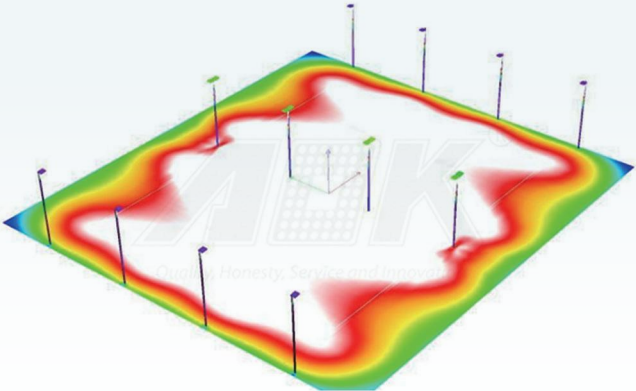
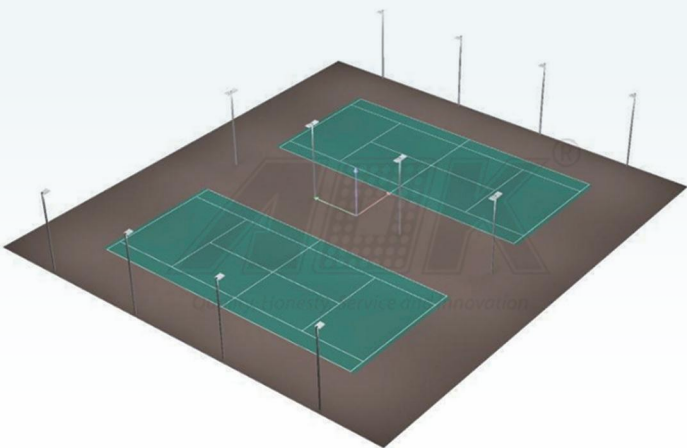

Explore the **Flexibility**

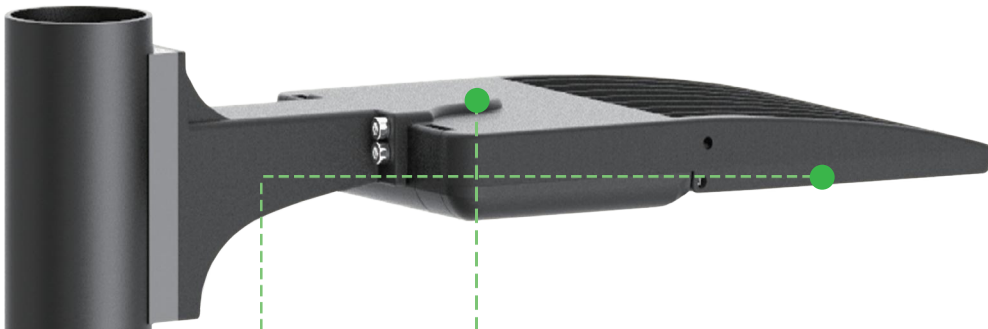

- Buckle design. Top cover space reserved for photocell sensor and bottom reserved for occupancy or PIR sensor with waterproof seal. **Flexible** for future installation.

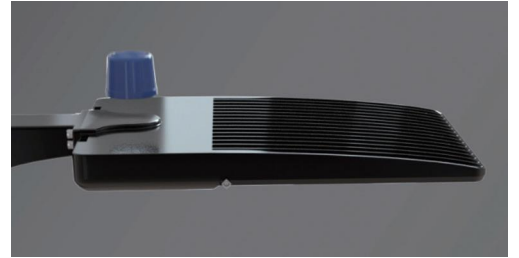

- **Flexible** design with 90° field-rotatable optics, simply rotate the lens and get light distribution in right direction in an instant.



Note: please ensure that the lens is not mounted facing the sky to prevent water from entering the lens area.

• Up to 7 installation methods (brackets) can be suitable for different installation scenarios, quickly adapt to the needs of the project. Convenient and **Flexible**.



Type A
Slipfitter (Φ40mm)

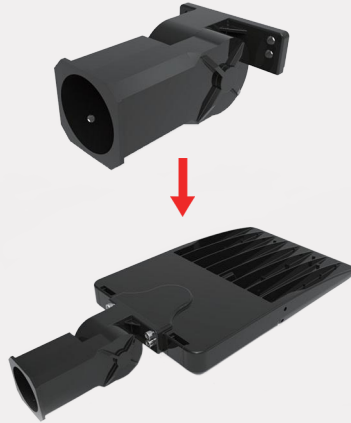

Type A
Slipfitter (Φ60mm)



Type A
Slipfitter (Φ76mm)

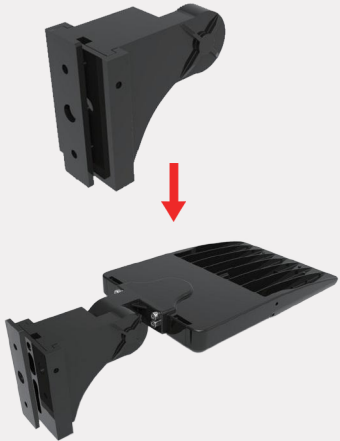

Type B
Adjustable Arm Mount



Type C
Yoke Mount

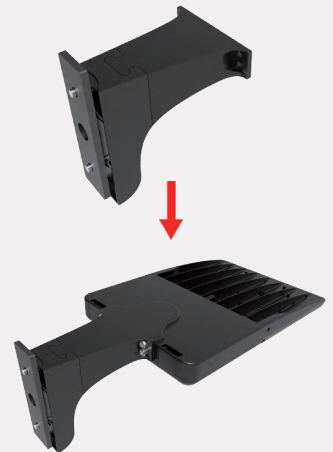

Type D
Slide & Lock Mount

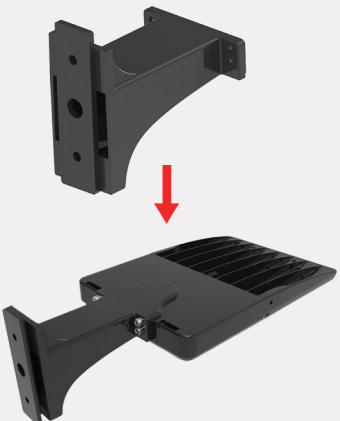

Type E
Square Pole Mount



Type F
Round Pole Mount



Type G
Trunnion Mount

Application Reference





Parameter Table

Electrical Data					
Model	AOK-230W ϕ T		AOK-300W ϕ T		AOK-420W ϕ T
Power(W)	230 W		300 W		420 W
Input voltage	Normal Voltage=100-277VAC, High Voltage=277-480VAC, please read *Note-1 before choosing.				
THD	7.70%		3.90%		7.70%
PF	0.99		0.99		0.99
Operating Temperature	-40°C to 50°C (-40 °F to 122 °F)				
Control Option	DALI, 1-10V/ PWM/ timer dimming, Nema, Zhaga, Presence detection sensor. Dim-to-Off with standby power <= 0.5W. DIP switch.				
Driver	Meanwell / Inventronics/Sosen				
Surge Protection	10kV / 20kV optional				
Photometric Data					
Efficacy(lm/W) (LUMILEDS,Std. Dev. \pm 5%)	T301(85°145°)	135 lm/W	126 lm/W	-	
	T302(80°155°)	160 lm/W	153 lm/W	142 lm/W	
	T401(70°125°)	135 lm/W	131 lm/W	-	
	T402(90°150°)	160 lm/W	149 lm/W	139 lm/W	
	T501(150°)	133 lm/W	130 lm/W	-	
Efficacy(lm/W) (SOUL,Std. Dev. \pm 5%)	T502(160°)	157 lm/W	155 lm/W	145 lm/W	
	T302(80°155°)	170 lm/W	167 lm/W	156 lm/W	
	T402(90°150°)	170 lm/W	160 lm/W	150 lm/W	
Luminous Flux (lm) (LUMILEDS)	T502(160°)	172 lm/W	170 lm/W	160 lm/W	
	T301(85°145°)	31123 lm	37868 lm	-	
	T302(80°155°)	36908 lm	45817 lm	59512 lm	
	T401(70°125°)	31121 lm	39157 lm	-	
	T402(90°150°)	36911 lm	44763 lm	58579 lm	
Luminous Flux (lm) (SEOUL)	T501(150°)	30492 lm	38953 lm	-	
	T502(160°)	36052 lm	46479 lm	60867 lm	
	T302(80°155°)	39156 lm	50167 lm	65599 lm	
ULOR	T402(90°150°)	39185 lm	48053 lm	63203 lm	
	T502(160°)	39569 lm	51087 lm	67305 lm	
CCT	= 0%, @ Luminaire inclination 0°				
CRI	3000K, 4000K, 5000K, 5700K, 6500K				
Beam Angle	70Ra, 80Ra, 90Ra optional				
LED Manufacturer	T301(85°145°)/T302(80°155°)/T312(60°120°)/T322(50°80°)/T401(70°125°)/T402(90°150°)/T501(150°)/T502(160°)/T512(150°)				
LED Model	LUMILEDS/SEOUL				
Working Current of Single LED (mA)	Lumileds 3030/Lumileds 5050/SEOUL 5050				
	T301(85°145°)	0.099	0.128	-	
	T302(80°155°)	0.055	0.071	0.099	
	T401(70°125°)	0.099	0.128	-	
	T402(90°150°)	0.055	0.071	0.099	
Lens	T501(150°)	0.099	0.128	-	
	T502(160°)	0.055	0.071	0.099	
Polycarbonate (Better impact resistance than glass)					
Mechanical Data					
IP/IK	IP66/IK10, according to standard EN 60529 and EN 62262				
Vibration Resistance	3G, conform to standard IEC 68-2-6.				
SCx	Front: 0.179268m ² ; Front-side: 0.0196 m ² ; Side: 0.03342 m ²		Front: 0.201256m ² ; Front-side: 0.0269 m ² ; Side: 0.04686 m ²		
Housing/Materials	Heavy-duty die-cast aluminum (EN AC-46100)				
Surface Treatment	Anti-UV thermosetting polyester / 80 micron epoxy primer + Anti-UV thermosetting polyester (for extremely corrosive environments).				
Painting	Black, Bronze, Customized color				
Cable	Pre-wired with a 70 cm cable (Other lengths on request)				
Mounting	Slip fitter(Φ40/60/76mm)/Arm mount/Yoke mount/Slide & lock/Square pole/Round pole/Trunnion				
Others					
Lifespan	L90B10 > 100000hrs, @Ta 25°C				
Warranty	5 years in standard, 10 years optional				
Certification	UL/cUL/FCC/CE/ENEC/SA/ RoHS,For other certificates please request				
Product Size	23.6*16.1*7.3 inches / 600*410*185 mm		25.6*16.7*15.0 inches / 650*423*380 mm		25.6*17.3*15.4 inches / 650*440*390 mm
Net Weight(\pm 10%)	5.6kg		8.9kg		9.6kg
Recommended Installation Height	General 4-12m, based on actual project requirements				
Application Field	Suitable for area lighting such as Tennis court				
Important Note!	The provided information is solely for reference; the official measurement report holds higher authority.				

* Note-1: For the power supply in the United States and Canada, in case the input voltage fluctuation \geq 240V the High Voltage solution is highly recommended for performance stability. Improper selection will cause damage to the driver or the light.

Dual LEDs CCT adjustable solution specification

Watt(W)	LED Chips	CCT	Current Output(mA)	Power(W)	Efficacy		
					T302	T402	T502
230	C84+W84	3000	1315	228.5	144	147	149
		4000		218.6	163	166	168
		5000		225.1	158	161	161
		5700		228.5	152	155	157

Ordering Information

AOK								
WATTS	VOLTAGE	LED CHIPS	TYPE OF SENSOR	CCT&CRI	DISTRIBUTION	MOUNT	HOUSING	OPTIONS
230WoT	NV=100-277V	L5=LUMILED 5050	00=Without Sensor	3070=3000K 70CRI	T301 (85*145°)	A=Slip Fitter	BK=Black	SPD 10KV
300WoT	HV=277-480V	S5=SOUEL 5050	SN=Motion Sensor	4070=4000K 70CRI	T302 (80*155°)	B=Adjustable Arm	BZ=Bronze	SPD 20KV
420WoT		W3=SOUEL W3	PH=Photocell	5070=5000K 70CRI	T312 (60*120°)	C=Yoke Mount	WH=White	DIP Switch
			DV=Dimmable	5770=5700K 70CRI	T322 (50*80°)	D= Slide and Lock	SI=Silver	
				6570=6500K 70CRI	T401 (70*125°)	E= Square Pole	RD=Red	
				3080=3000K 80CRI	T402 (90*150°)	F= Round Pole	BL=Blue	
				4080=4000K 80CRI	T501 (150°)	G= Trunnion Mount		
				5080=5000K 80CRI	T502 (160°)			
				5780=5700K 80CRI	T512 (150°)			
				6580=6500K 80CRI				

Photometry

T301 (85*145°)

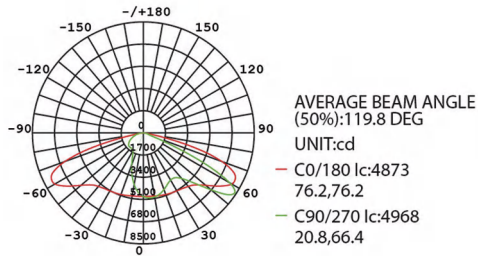

T302 (80*155°)

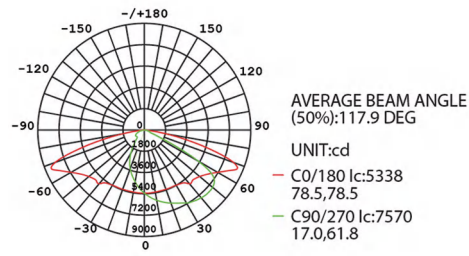

T312 (60*120°)

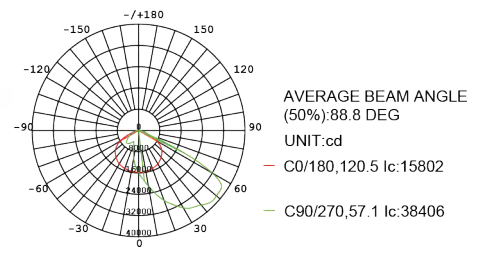

T322 (50*80°)

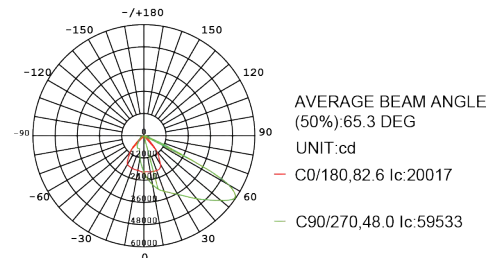

T401 (70*125°)

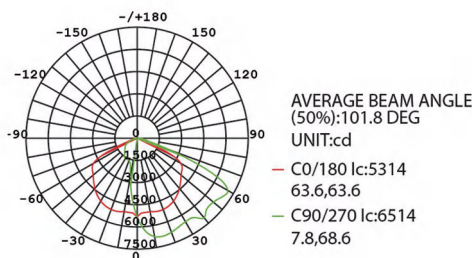

T402 (90*150°)

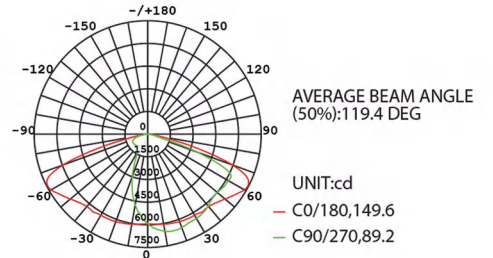

T501 (150°)

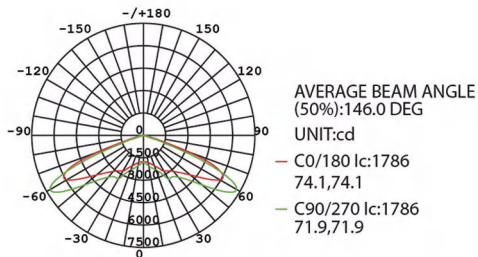

T502 (160°)

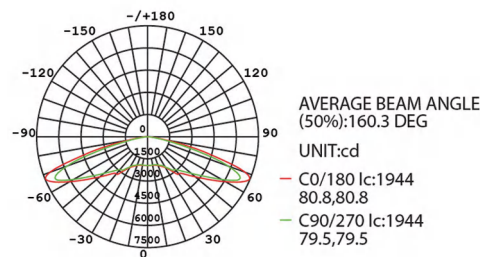

T512 (150°)

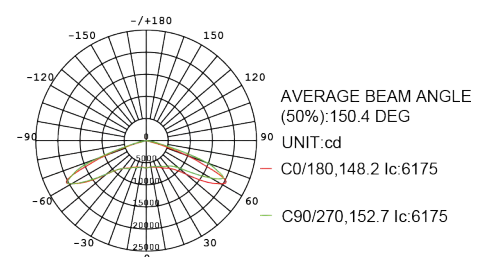

Illuminance Diagram

T301 (85°*145°)

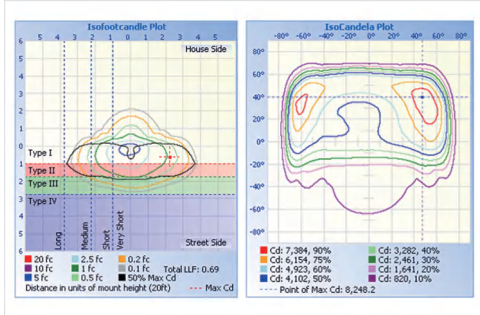

T302 (80°*155°)

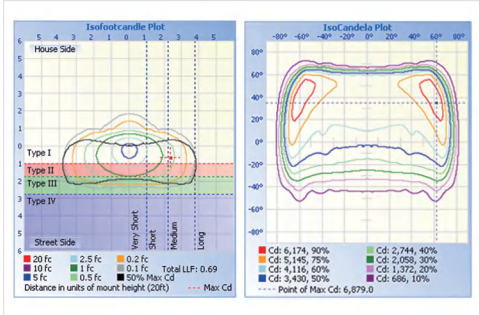

T312 (60°*120°)

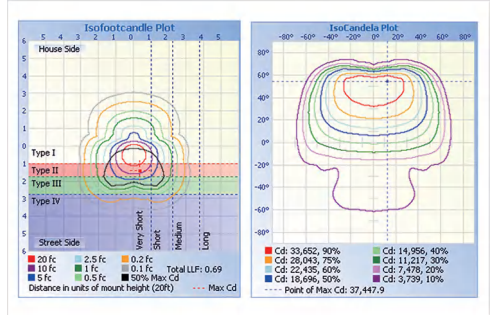

T322 (50°*80°)

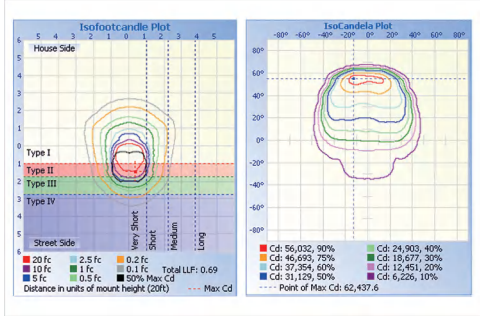

T401 (70°*125°)

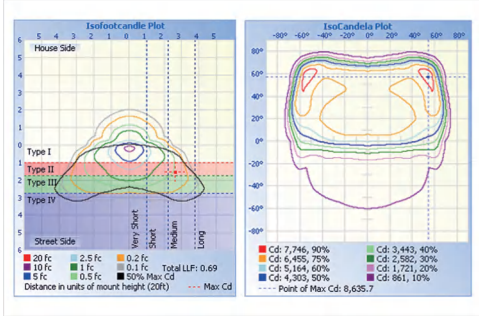

T402 (90°*150°)

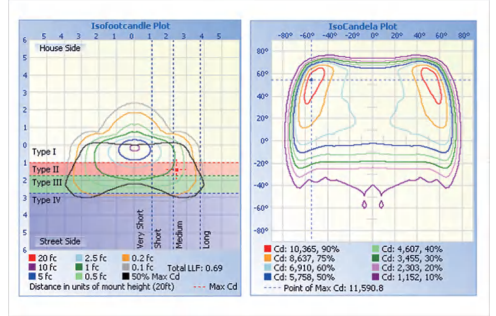

T501 (150°)

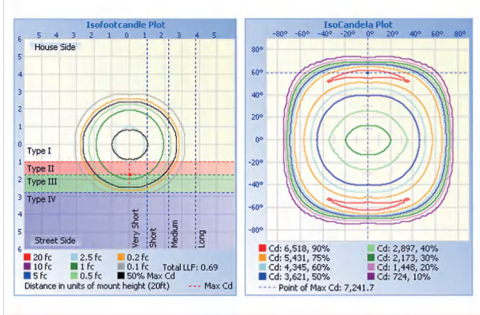

T502 (160°)

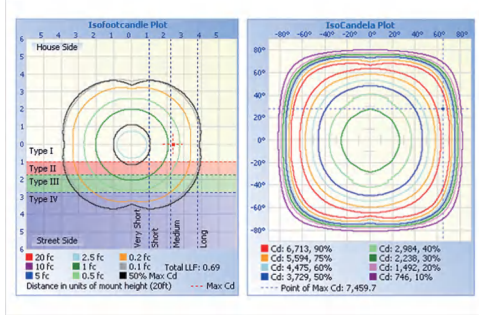

T512 (150°)

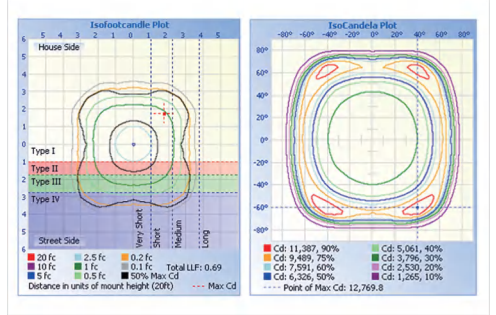

Dimension and Visor Installation Method

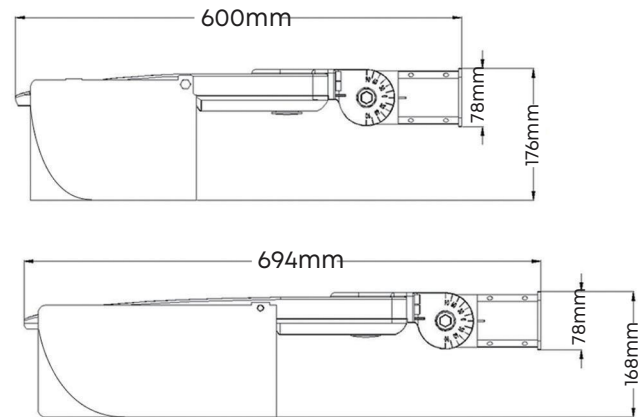

Step1: Align the light shield to the corresponding hole of the lamp body



Step2: Fix it with M8 screws



Step3: Hook the hook of the light shield to the lamp body



Step4: The installation is complete



Construction Features

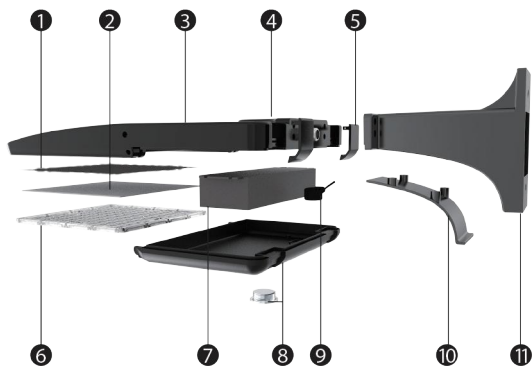

1. Super efficient heat dissipation layer
2. Light source: PCB board with LEDs
3. Die casting aluminum unibody main housing, IP66
4. Space for 5/7 pin receptacle upgradable for photocell sensor and smart systems
5. Tool-less buckle to driver access panel
6. Optical grade rotatable PC lens Type III / IV / V
7. Top level 1-10V dimmable driver 100-277V / 277V-480V optional
8. Tool free driver access panel with space reserved for occupancy sensor covered by removable cap fits with Wattstopper FSP sensor
9. Surge protection device
10. Bracket access panel for wiring
11. Exchangable bracket fits round / square pole. Other brackets optional such as yoke, trunnion, etc

Bracket

Type A Slipfitter	Type B Adjustable Arm Mount	Type C Yoke Mount	Type D Slide & Lock Mount	Type E Square Pole Mount	Type F Round Pole Mount	Type G Trunnion Mount
TypeA: 1.1kg	TypeB: 2.0kg	TypeC: 75W-145W 0.9kg 180-230W 1.0kg 300-420W 1.5kg	TypeD: 1.1kg	TypeE: 1.1kg	TypeF: 1.4kg	TypeG: 1.4kg

C- bracket standard material: SPCC.

The bracket may rust if used for an extended period, but it does not affect the lifespan of the light fixture itself. If there are specific requirements (whether it's regarding the material or the shape), please specify them before placing an order.

Accessories

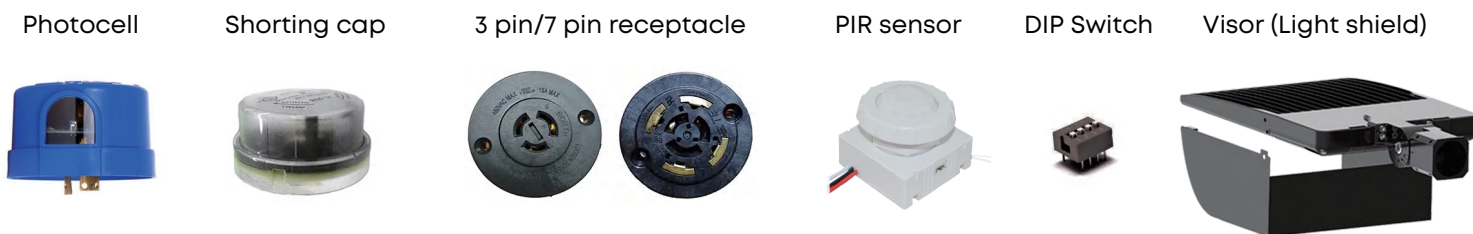

*As the products are upgraded, the accessories may differ from those described in the pictures. Please consult with our sales team for updated details and order separately.



Quality, Honesty, Service and Innovation

Innovative & Tailored Lighting Solutions for **Success**



5 Year Limited Warranty,
10 Year Preferred Warranty.
Please consult with our sales for detailed agreement.

wally@aokledlight.com

www.aokledlight.com

+1 626-986-4050 (US)

+86 755 2357 9148 (CN)

Manufacturing:

Shenzhen: Building 1 & 4, St. George's Science and Technology Industrial Park, Shajing Street, Shenzhen, China, 518124.

Huizhou: Building 2, Yinghui Electronic Science and Tech Park, No. 6 Dongsheng North Rd, Chenjiang Street, Zhongkai High-tech Zone, Huizhou, China. 516006.

Fuzhou HQ: Room 301, Yujing Business Center Zone 1, No. 12 Baihuazhou road, Cangshan district, Fuzhou, China, 350007

Copyright ©2024 AOK LED LIGHT CO., LTD. All Right Reserved.