

**200+** Patent Certificates  
**\$1,000,000+** Annual Energy Saving  
**10,000+** Projects Successfully Installed



# IL03 LED Street Light

Power: 20W - 230W













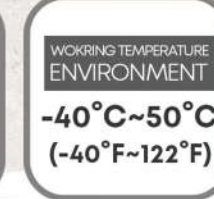

Innovative & Tailored  
Lighting Solutions for **Success**  
[www.aokledlight.com](http://www.aokledlight.com)

# Features of **IL03** Series

The IL03 series offers an economically efficient and adaptable street light/area light solution with exceptional cost-effectiveness.

- Power output spans from 20W to 230W.
- Features a sleek fixture body design adhering to industrial-grade standards.
- Utilizes micro-lens systems to generate IESNA Type II, Type III, Type IV, and Type V distributions.
- Ensures 0% total lumens above 90 ° (BUG Rating, U=0), ensuring uniform light output and reduced glare.
- Optical systems maintain an IP66 rating for durability.
- Includes a designated spot atop the fixture for potential future sensor installation.
- Installation is hassle-free, with simple maintenance requirements.

 <b>PATENTED PRODUCT</b>	 <b>UPTO 145</b> lm/W	 <b>L90B10</b> <b>&gt;100,000HRS</b> @ 25 C	 <b>100-277VAC</b> 50 / 60HZ	 <b>THD</b> <b>&lt; 20%</b>
 <b>ULR</b> <b>= 0%</b>	 <b>DIM</b>	 <b>WORKING TEMPERATURE ENVIRONMENT</b> <b>-40°C~50°C</b> <b>(-40°F~122°F)</b>	 2 7 0 0 K 3 0 0 0 K 4 0 0 0 K 5 0 0 0 K 5 7 0 0 K 6 5 0 0 K	 <b>CRI</b> <b>Ra70/80/90</b>
 <b>IP66</b> <b>IK09</b>	 <b>3G</b> VIBRATION TESTING PASSED			



For other certificates please request

## Benefits for choosing IL03

-  **Convenient Upgrade**  
Reserve sensor installation port for easy upgrading.
-  **Efficient Heat Dissipation**  
Rear fin-shaped heat sink design, fast convection, excellent heat dissipation, low temperature.
-  **Solar Power Optional**  
Support solar power optional configuration, please consult for details.
-  **Exceptional Impact Resistance**  
Passed 3G Shock Resistance Test.
-  **Professional Optic Design**  
Multiple light distribution options available, professional simulation design.
-  **Multiple Accessories and Options**  
Supports accessories and options such as Photocell (Nema), 3pin/7pin bases, ZigBee, LoRa, Zhaga bases, Dali, Casambi, NB-IoT control, and more.

# Photometric Design

## For the sake of adaptability

• Optimized, premium optical grade Mitsubishi polycarbonate lens, the efficient design of the modules make each light engine highly customizable, allowing the light distribution to be aimed toward the applications.

### Distribution Type

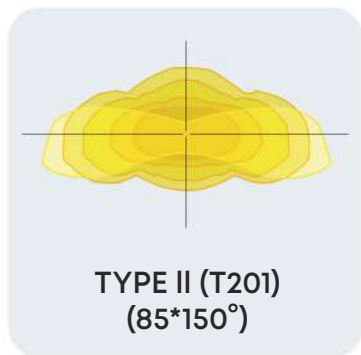

Asymmetric, Type II can be used in long and narrow aisles/lanes/side walks.

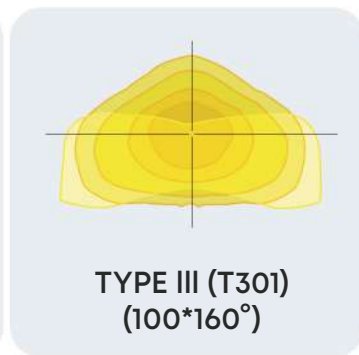

Asymmetric, Type III can be used in wide road parking areas, or at corner areas.

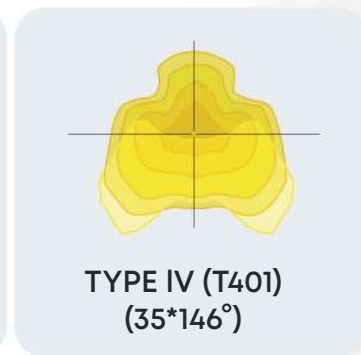

Asymmetric, Type IV can be used in wide road parking areas, or at corner areas.

\* Due to working temperature and CCT/CRI adjustments, actual photometric values may vary slightly. Please consult the measured IES file for accurate data. The above information is for reference purposes only.

Lumileds 3030 LED chip

The photometric engine takes advantage of the latest generation of mid-power LEDs and dedicated optics for professional applications. Combined with Lumileds 3030 it provides an alternative solution for those who are looking for very cost-effective yet efficient lighting while keeping the same luminaire design.

# Smart Control Ready

## For Efficient Management

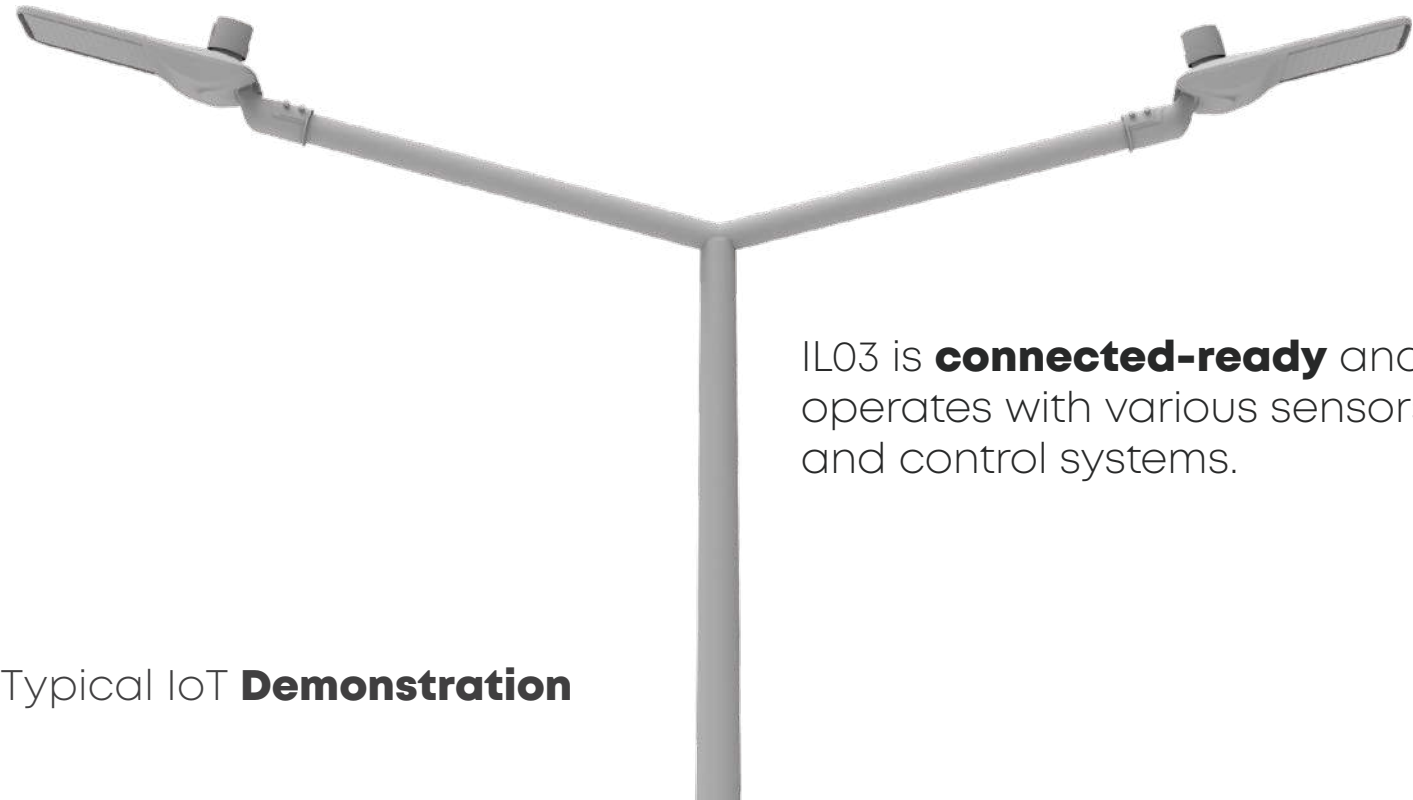

IL03 is **connected-ready** and operates with various sensors and control systems.

### Typical IoT **Demonstration**

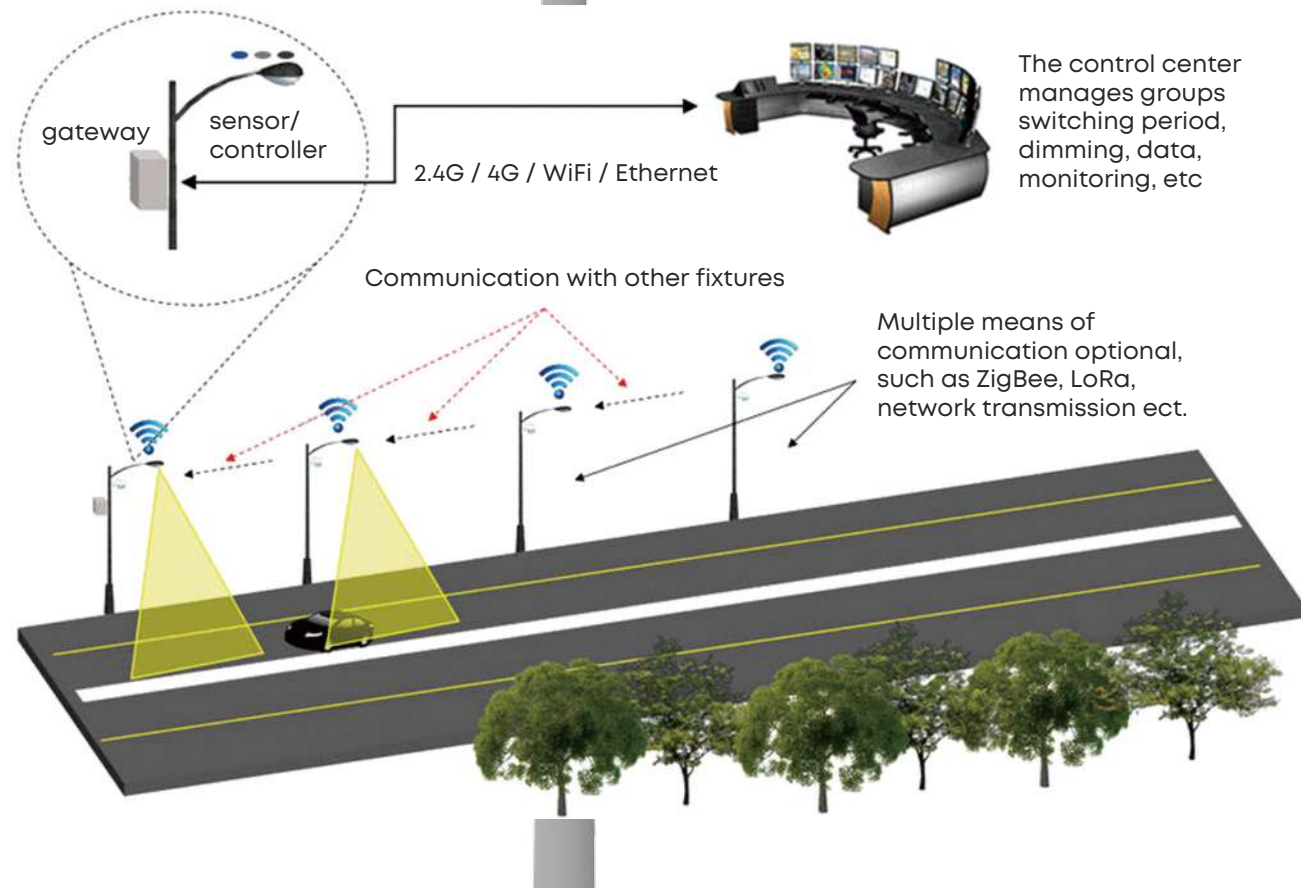

### Custom Dimming Profile

Smart luminaire drivers enable the programming of complex dimming profiles without extra wiring. Customized time intervals and light levels contribute to maximum energy savings, maintaining required lighting levels and uniformity throughout the night.

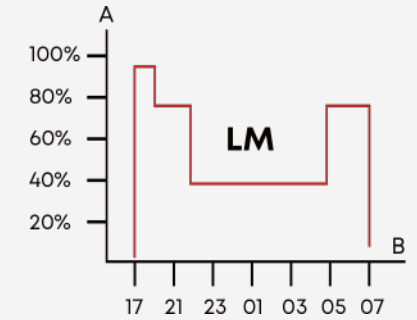

### Daylight Sensor / Photocell

Photocell or daylight sensors switch the luminaire on as soon natural light falls to a certain level. It can be programmed to switch on during a storm, on a cloudy day (in critical areas) or only at nightfall so as to provide safety and comfort in public spaces.

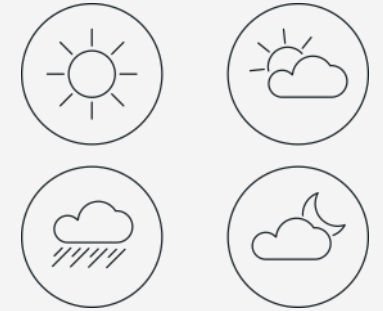

### Smart standards. Smarter lighting.

LoRaWAN® Luminaire Controller Zhaga is a wireless device for remote LED luminaire control with a Zhaga-compliant connector and DALI interface. It's compatible with LoRaWAN®, NB-IoT, and LTE-M networks, featuring a modern, compact design suitable for various street lighting modules.

LoRaWAN® Luminaire Controller NEMA is designed for LED luminaires with an ANSI C136.41 NEMA receptacle. It controls the luminaire through DALI or 0-10V analog interfaces and provides a secure power connection with three robust twist lock contacts.

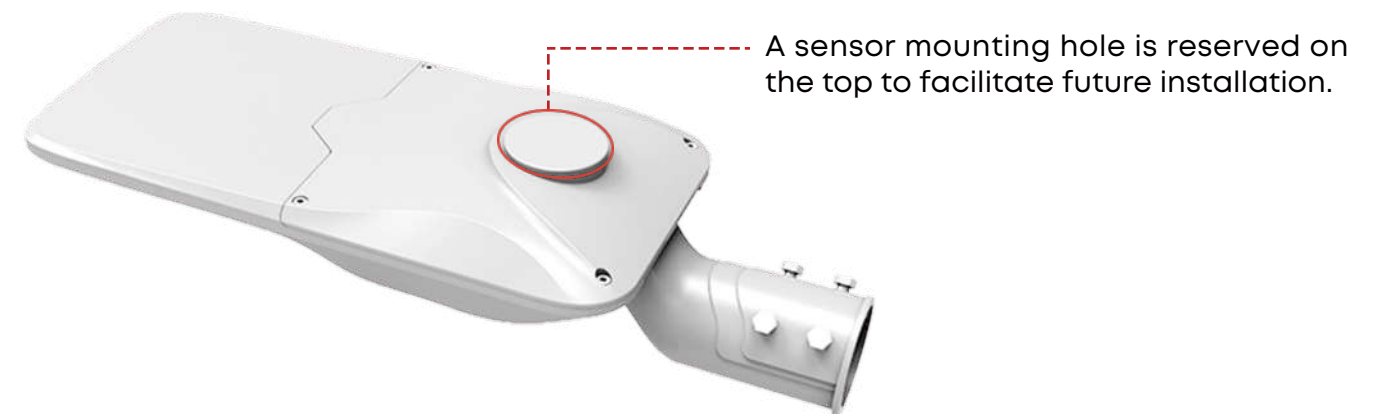

# Application Reference

- Road & highway lighting
- Urban road & street lighting
- Residential area lighting
- Parks & perimeter lighting
- Parking lot lighting
- Riverside & jogging track



# Parameter Table

Electrical Data							
Model	AOK-20WIL03	AOK-30WIL03	AOK-50WIL03	AOK-60WIL03	AOK-70WIL03	AOK-80WIL03	
Power(W)	20 W	30 W	50 W	60 W	70 W	80 W	
Input voltage	100-277VAC						
THD	<20%						
PF	≥0.95	≥0.95	≥0.95	≥0.98	≥0.98	≥0.98	
Driver	Meanwell / Sosen / Philips. Class 1/ Class 2, EU						
Operating temperature	-40°C to 50°C (-40 °F to 122 °F)						
Storage temperature	-40°C to 80°C (-40 °F to 176 °F)						
Control Option	Surge Protective Device、Daylight Sensor Control、1-10V Dimming						
Surge Protection	10kV / 20kV optional						
Photometric Data							
Efficacy(lm/W) (CRI 70Ra, 5000K) (Std Dev ±5%)	T201	145lm/W	145lm/W	140lm/W	135lm/W	140lm/W	135lm/W
	T301	145lm/W	145lm/W	140lm/W	135lm/W	140lm/W	135lm/W
	T401	145lm/W	145lm/W	140lm/W	135lm/W	140lm/W	135lm/W
Luminous flux (lm) (CRI 70Ra, 5000K) (Std Dev ±5%)	T201	2900lm	4350lm	7000lm	8100lm	9800lm	10800lm
	T301	2900lm	4350lm	7000lm	8100lm	9800lm	10800lm
	T401	2900lm	4350lm	7000lm	8100lm	9800lm	10800lm
ULR	= 0%, @ Luminaire inclination 0°						
CCT	2700K, 3000K, 4000K, 5000K, 5700K, 6500K						
CRI	70Ra, 80Ra, 90Ra optional						
Beam angle	T201(85°150°)/T301(100°160°)/T401(35°146°)						
LED Manufacturer	LUMILEDS						
LED model	Lumileds 3030						
Working current of single LED (mA)	T2	40mA	60mA	100mA	120mA	90mA	110mA
	T3	40mA	60mA	100mA	120mA	90mA	110mA
	T4	40mA	60mA	100mA	120mA	90mA	110mA
Lens	Polycarbonate						
Mechanical Data							
IP/IK	IP66/IK09, according to standard EN 60529 and EN 62262						
Vibration resistance	3G, conform to standard IEC 68-2-6.						
EPA(SCx)	Front: 1.32ft² (0.122632m²); Side: 0.34ft² (0.031587m²);						
Materials	Heavy-duty die-cast aluminum (EN AC-46100)						
Painting	Black, Silver, Customized color						
Surface treatment	Anti-UV thermosetting polyester / 80 micron epoxy primer + Anti-UV thermosetting polyester (for extremely corrosive environments).						
Cable	Pre-wired with a 30 cm cable (Other lengths on request)						
Mounting	Side entry						
Others							
Lifespan	L90B10 > 100000hrs, @Ta 25°C						
Warranty	5 years in standard, 10 years optional						
Product size	551*214*136mm / 21.7*8.43*5.35 inches						
Carton size	24.21*10.43*8.27" / 615*265*210mm						
Net weight	3.1kg / 6.83 lbs	3.1kg / 6.83 lbs	3.1kg / 6.83 lbs	3.1kg / 6.83 lbs	3.1kg / 6.83 lbs	3.8kg / 8.38 lbs	
Gross weight	4.3kg / 9.48 lbs	4.3kg / 9.48 lbs	4.3kg / 9.48 lbs	4.3kg / 9.48 lbs	4.3kg / 9.48 lbs	5kg / 11.02 lbs	
Recommend installation height	General 4-12m, based on actual project requirements						
Application field	Urban and rural street						
Important note!	The provided information is solely for reference; the official measurement report holds higher authority.						

Electrical Data								
Model	AOK-100WIL03	AOK-120WIL03	AOK-150WIL03	AOK-180WIL03	AOK-200WIL03	AOK-230WIL03		
Power(W)	100 W	120 W	150 W	180 W	200 W	230 W		
Input voltage	100-277VAC							
THD	<20%							
PF	≥0.98	≥0.98	≥0.98	≥0.98	≥0.98	≥0.98		
Driver	Meanwell / Sosen / Philips. Class 1/ Class 2, EU							
Operating temperature	-40°C to 50°C (-40 °F to 122 °F)							
Storage temperature	-40°C to 80°C (-40 °F to 176 °F)							
Control Option	Surge Protective Device、Daylight Sensor Control、1-10V Dimming							
Surge Protection	10kV / 20kV optional							
Photometric Data								
Efficacy(lm/W) (CRI 70Ra, 5000K) (Std Dev ±5%)	T201	135lm/W	135lm/W	135lm/W	140lm/W	135lm/W	135lm/W	
	T301	135lm/W	135lm/W	135lm/W	140lm/W	135lm/W	135lm/W	
	T401	135lm/W	135lm/W	135lm/W	140lm/W	135lm/W	135lm/W	
Luminous flux (lm) (CRI 70Ra, 5000K) (Std Dev ±5%)	T201	13500lm	16200lm	20250lm	25200lm	27000lm	31050lm	
	T301	13500lm	16200lm	20250lm	25200lm	27000lm	31050lm	
	T401	13500lm	16200lm	20250lm	25200lm	27000lm	31050lm	
ULR	= 0%, @ Luminaire inclination 0°							
CCT	2700K, 3000K, 4000K, 5000K, 5700K, 6500K							
CRI	70Ra, 80Ra, 90Ra optional							
Beam angle	T201(85°150°)/T301(100°160°)/T401(35°146°)							
LED Manufacturer	LUMILEDS							
LED model	Lumileds 3030							
Working current of single LED (mA)	T2	135mA	115mA	145mA	120mA	135mA	150mA	
	T3	135mA	115mA	145mA	120mA	135mA	150mA	
	T4	135mA	115mA	145mA	120mA	135mA	150mA	
Lens	Polycarbonate							
Mechanical Data								
IP/IK	IP66/IK09, according to standard EN 60529 and EN 62262							
Vibration resistance	3G, conform to standard IEC 68-2-6.							
SCx	Front: 1.32ft² (0.122632m²); Side: 0.34ft² (0.031587m²);	Front: 1.77ft² (0.164438m²); Side: 0.37ft² (0.034374m²);				Front: 2.15ft² (0.2m²); Side: 0.44ft² (0.0413m²);		
Materials	Heavy-duty die-cast aluminum (EN AC-46100)							
Painting	Black, Silver, Customized color							
Surface treatment	Anti-UV thermosetting polyester / 80 micron epoxy primer + Anti-UV thermosetting polyester (for extremely corrosive environments).							
Cable	Pre-wired with a 30 cm cable (Other lengths on request)							
Mounting	Side entry							
Others								
Lifespan	L90B10 > 100000hrs, @Ta 25°C							
Warranty	5 years in standard, 10 years optional							
Product size	551*214*136mm / 21.7*8.43*5.35 inches		621*254*136mm / 24.45*10*5.35 inches			756*308*138mm / 29.76*12.13*5.43 inches		
Carton size	615*265*210mm / 24.2*10.43*8.27 inches		685*305*210mm / 26.97*12*8.27 inches			825*360*205mm / 32.48*14.17*8.07 inches		
Net weight	3.8kg / 8.38 lbs		4kg / 8.82 lbs		4kg / 8.82 lbs		5.6kg / 12.35 lbs	
Gross weight	5kg / 11.02 lbs		5.5kg / 12.13 lbs		5.5kg / 12.13 lbs		6.9kg / 15.21 lbs	
Recommend installation height	General 4-12m, based on actual project requirements							
Application field	Urban and rural street							
Important note!	The provided information is solely for reference; the official measurement report holds higher authority.							

## IL03 Series Specification Sheet

\*Due to the constant improvements in product development, individual parameters might change. Please refer to our sales or R&D team for most up-to-date content as specifications are subject to change without notice.

wally@aokledlight.com  
+1 626-986-4050 (US)  
+86 755 2357 9148 (CN)

©2024 AOK LED LIGHT CO., LTD. All Right Reserved.



## Ordering Information

AOK	WATTS	VOLTAGE	LED CHIPS	TYPE OF SENSOR	CCT&CRI	DISTRIBUTION	MOUNT	HOUSING	OPTIONS
	20WIL03	NV=100-277V	L3=LUMILEDS 3030	00=Without Sensor	2770=2700K 70CRI	T201 (85°150°)	A=Side Entry	SG=Silver Gray	10KV SPD
	30WIL03			PH=Photocell	3070=3000K 70CRI	T301 (100°160°)		BK=Black	20KV SPD
	50WIL03			DV=Dimmable	4070=4000K 70CRI	T401 (35°146°)			
	60WIL03				5070=5000K 70CRI				
	70WIL03				5770=5700K 70CRI				
	80WIL03				6570=6500K 70CRI				
	100WIL03				2780=2700K 80CRI				
	120WIL03				3080=3000K 80CRI				
	150WIL03				4080=4000K 80CRI				
	180WIL03				5080=5000K 80CRI				
	200WIL03				5780=5700K 80CRI				
	230WIL03				6580=6500K 80CRI				

## Illuminance Diagram

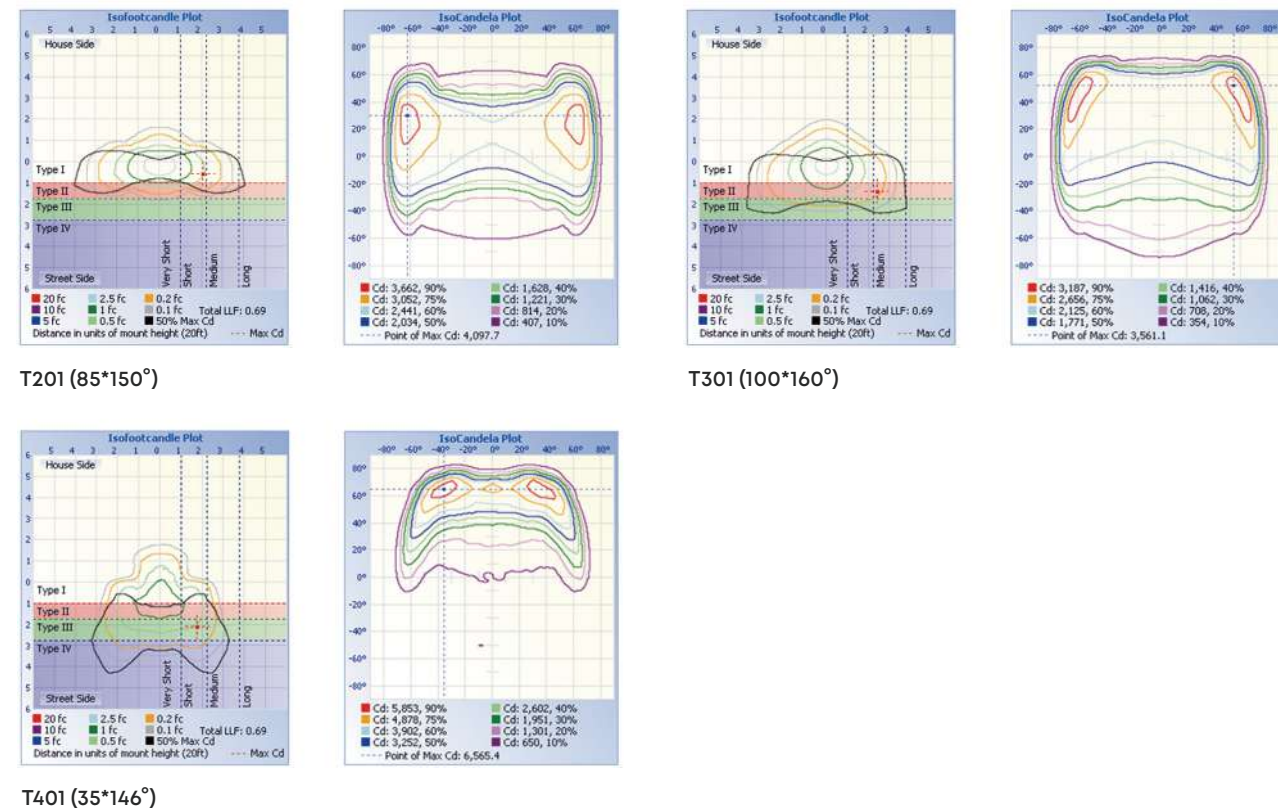

## Accessories



\*As the products are upgraded, the accessories may differ from those described in the pictures. Please consult with our sales team for updated details and order separately.

## Construction Features

### Electrical

- Driver Efficiency: >86%~>93%; Maximum Current: AC0.22 A (max)~AC2.5 A (max)
- 1-10V/ PWM/ Timer dimming, 3 Timer Modes, Dim-to-Off with standby power <= 0.5W.
- Constant current Class I driver, 100-277Vac, 50-60Hz, Class II optional.
- High efficiency driver: PF>0.95, driver efficiency >92%.
- Input Surge Protection: 6kV line-line, 10kV line-earth, 20KV SPD available.
- Operating temperature rating: -40° F to 122° F (-40° C to 50° C).
- Compatible with DALI, Zhaga / Nema standards, Presence detection sensor.

### Construction

- Robust die-cast aluminum housing.
- UV stabilized polyester powder paint finish for durability and corrosion resistance.
- Side entry installation.
- Uniform luminous flux and low glare design.
- IP66 & IK09.
- 3G vibration rating.

## Dimension



20W-100W

120W-150W

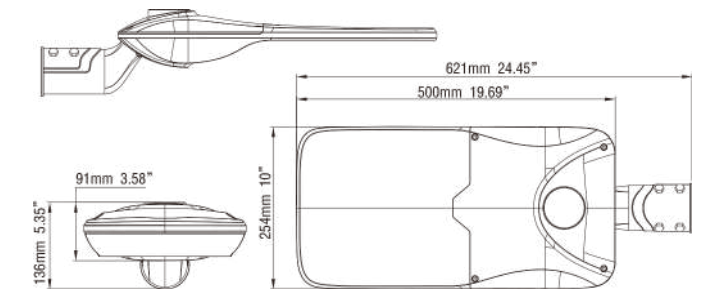
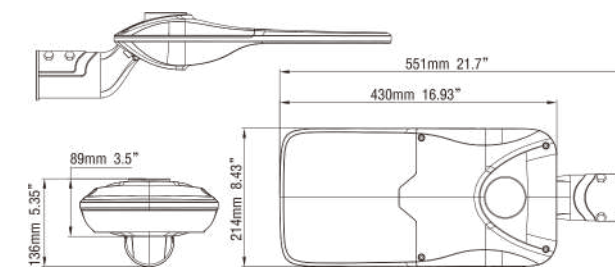

180W-230W

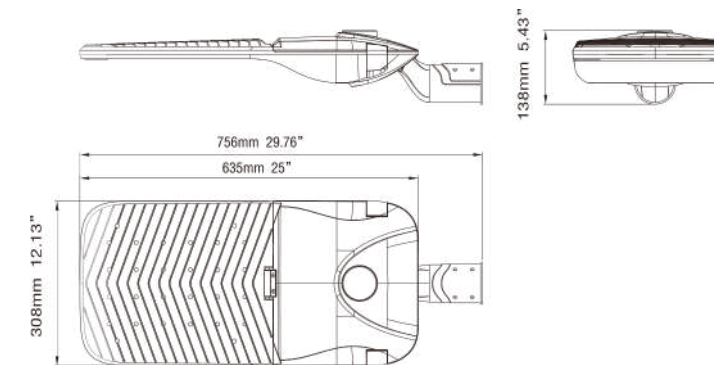

## IL03 Series Specification Sheet

\*Due to the constant improvements in product development, individual parameters might change. Please refer to our sales or R&D team for most up-to-date content as specifications are subject to change without notice.

wally@aokledlight.com  
+1 626-986-4050 (US)  
+86 755 2357 9148 (CN)

©2024 AOK LED LIGHT CO., LTD. All Right Reserved.





# Innovative & Tailored Lighting Solutions for **Success**

**5** **10** **WARRANTY**  
5 Year Limited Warranty,  
10 Year Preferred Warranty.  
Please consult with our sales for detailed agreement.

wally@aokledlight.com  
www.aokledlight.com  
+1 626-986-4050 (US)  
+86 755 2357 9148 (CN)

Manufacturing: Building 1 & 4, St. George's Science and Technology Industrial Park, Shajing Street,  
Shenzhen, China, 518124.  
Fuzhou HQ: Room 301, Yujing Business Center Zone 1, No. 12 Baihuazhou road, Cangshan district,  
Fuzhou, China, 350007  
North America HQ: 17531 Railroad St, Suite F, City of industry CA91748 USA

Copyright ©2024 AOK LED LIGHT CO., LTD. All Right Reserved.